

SW-71A(C/D3/E/F/H) Chainguard Bracket

• Material: ED Steel
SW-71A/E/F: fit inner BB $\phi 35\text{mm}$ / outer BB $\phi 40\sim 45\text{mm}$ / BC 1.37" x 24 T.P.I.
SW-71C: fit $\phi 35\text{mm}$ BB only.



BRACKET & CHAINCOVER SYNOPSIS

SINGLE SPEED

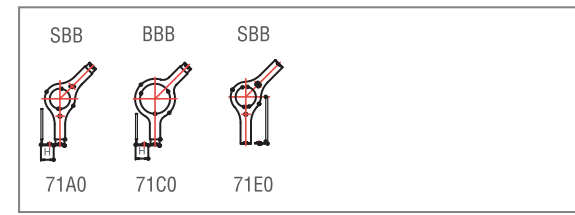

MODEL NUMBER	Available bracket
SW-CG-131	71A0
SW-768	71C0, 71E0
SW-771	
SW-772	
SW-773	71A0, 71C0
SW-777	
SW-780	
SW-780C	71A1, 71C0
SW-7802	
SW-788	71E1 clamp ($\phi 25.4$, $\phi 28.6$, $\phi 31.8$, $\phi 35$, $\phi 38.1$)

SBB	CHAIN CASE	Available bracket
71E0	SW-775	71E0
	SW-775S1-S3	



TRIPLE SPEED



MODEL NUMBER	Available bracket
SW-761	71D3
SW-7714	71A3
SW-7724	71A3
SW-7734	71A3
SW-799	71A1

CHILD BIKE

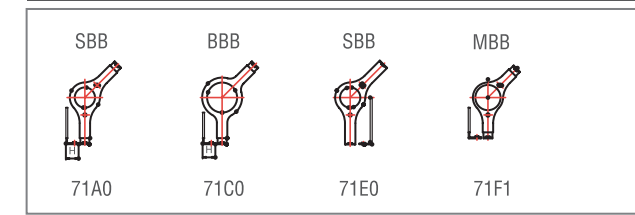

CHILD BIKE	Available bracket
SW-792	71A0, 71C0
SW-76001-03	
SW-760S1-S3	60SS, 60SM, 60SL
SW-760M1-M3	
SW-760L1-L3	60LS, 60LM, 60LL

E-BIKE (SHIMANO) E-BIKE (BAFANG) E-BIKE (BOSCH)

E-BIKE (SHIMANO)			E-BIKE (BAFANG)			E-BIKE (BOSCH)					
Type	Chain Case	Bracket	Type	Chain Case	Bracket	Type	Chain Case	Bracket			
DU-E5000 DU-E6100	SW-CG-173A	71K6	MM G360.250 M300	SW-CG-173A SW-CG-173A1	7110	Active Line Active Line Plus (Gen3)	SW-CG-173A	71J0			
	SW-CG-117	CG-117C					SW-CG-173A1	71J1			
	SW-CG-139	71H2-05					SW-CG-173B	71J2			
DU-E6001 DU-E6010 DU-E6050	SW-CG-173A SW-CG-173A1	71K2		SW-CG-173B	7111		7112	SW-CG-113	71J3		
	SW-CG-173B	71K4						SW-7802	71J4		
	SW-CG-139	71H0-03						SW-7802	7113	SW-CG-117	71J4
	SW-CG-113	71H0-01								SW-CG-173A SW-CG-173A1	71H1-01
	SW-780	71H0-02								SW-CG-173B	71H1-02
DU-E7000 DU-E8000	SW-CG-173A SW-CG-173A1	71K3		SW-CG-117	7114		Performance Line speed (Gen4)	SW-CG-139	71H1-05		
	SW-CG-173B	71K5						SW-CG-113	71H1-03		
	SW-CG-117	71K1	SW-7802			71H1-04					
EP8	SW-CG-173A SW-CG-173A1	71K3-1	MM G330.250 M400	SW-CG-117	7114-1						

SW-760 Chain Guard

- Material: (Standard)ABS or PC
- Finish: Gloss
- Different sizes of front and rear chainguard offer bikers more choices.
- The SW-760 full-chaingurd series provide you suitable sizes as your requirement.



12"		Final item No.: 76001 Teeth: 28T R.C. Range: 240~265mm	Final item No.: 760S1 Teeth: 28T R.C. Range: 215~240mm	Final item No.: 760M1 Teeth: 32~36T R.C. Range: 270~295mm	Final item No.: 760L1 Teeth: 32~36T R.C. Range: 300~325mm
14"-16"		Final item No.: 76002 Teeth: 28T R.C. Range: 275~300mm	Final item No.: 760S2 Teeth: 28T R.C. Range: 250~275mm	Final item No.: 760M2 Teeth: 32~36T R.C. Range: 305~330mm	Final item No.: 760L2 Teeth: 32~36T R.C. Range: 335~360mm
18"		Final item No.: 76003 Teeth: 28T R.C. Range: 300~325mm	Final item No.: 760S3 Teeth: 28T R.C. Range: 275~300mm	Final item No.: 760M3 Teeth: 32~36T R.C. Range: 330~355mm	Final item No.: 760L3 Teeth: 32~36T R.C. Range: 360~385mm
20"		Final item No.: 760X Teeth: 32~36T R.C. Range: 390~420mm			



- Prevent children from touching the rear chain.
- Decrease gap between the forks to the ISO 8098 4.15 safety standard.

S Fit inner chainguard of B.B. size $\phi 35\text{mm}$ or B.C. 1.37"x24T.P.I.

M Fit inner chainguard of B.B. size $\phi 43.5\text{mm}$

L Fit inner chainguard of B.B. size $\phi 51.5\text{mm}$

SPECIFICATION LIST OF SW-760 SERIES

MODEL	TEETH	INNER DIAMETER OF CHAIN GUARD	R.C. RANGE	SUITABLE INNER CHAIN GUARD MODEL NUMBER						REMARK
				60SS	60SM	60SL	60LS	60LM	60LL	
SW-760S1	28T	$\phi 90$	215~240mm							
SW-760S2			250~275mm							
SW-760S3			275~300mm							
SW-76001			240~265mm	•	•	•				
SW-76002			275~300mm							
SW-76003			300~325mm							
SW-760L1	32T~36T	$\phi 90$	300~325mm							
SW-760L2			335~360mm							
SW-760L3			360~385mm							
SW-760M1			270~295mm				•	•	•	
SW-760M2			305~330mm							
SW-760M3			330~355mm							
SW-760X	32T~36T		390~420mm							

SW-719 Chain Cover

- Material: PC
- Finish: Gloss
- Fit models with crank/chain wheel distance between 6~16mm.



WITHIN $\langle 42-44T \rangle$ TEETH

STANDARD

15mm 11mm

OPTIONAL

70F
For non-threaded BB

SW-722(A) Chain Cover

- Material: PC
- Finish: Gloss
- BCD:104mm

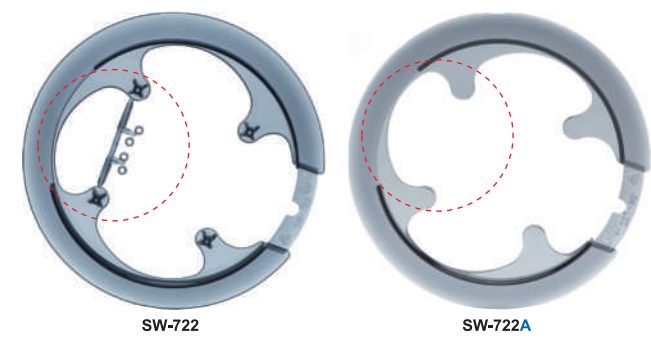

WITHIN $\langle 42-44T \rangle$ TEETH

STANDARD

15mm 11mm

OPTIONAL

70F
For non-threaded BB

SW-720 Chain Cover

- Material: PC
- Finish: Gloss
- Fit models with crank/chain wheel distance between 6~16mm.



WITHIN $\langle 46-48T \rangle$ TEETH

STANDARD

15mm 11mm

OPTIONAL

70F
For non-threaded BB

SW-780 Chain Guard

- Material: PC
- Finish: Gloss



780 INNER DIAMETER SPEC.

MODEL	MIDDLE HOLE DIAMETER	REMARKS
SW-780	ø120mm	
SW-7801	ø80mm	
SW-7802	ø102mm	
SW-7803	ø112mm	
SW-780C	ø80mm	with colorful pad ring to make the whole bike vivid.

SW-780A Chain Guard

- Material: PC
- Finish: Matt (Etched)



780 INNER DIAMETER SPEC.

MODEL	MIDDLE HOLE DIAMETER
SW-780A	ø120mm
SW-7802A	ø102mm

SW-CG-139 Chain Guard

- Material: PC / ABS
- Finish: Gloss
- Designed with an auxiliary reflector for extra safety.



SW-CG-117 Chain Guard

- Material: PC
- Finish: Gloss



SW-CG-173A1 Chain Guard

- Material: PC
- Finish: Gloss



CHAIN GUARD

SW-792 Chain Guard

- Material: ABS
- Finish: Gloss
- Fit 20" rear end with extended mounting hole.



CHAIN GUARD

SW-CG-173A Chain Guard

- Material: PC
- Finish: Gloss



SW-CG-113 Chain Guard

- Material: PC
- Finish: Gloss
- Color customizable window plate.



SW-771(7714) Chain Guard

- Material: PC
- Finish: Gloss



SW-7714

SW-CG-133 Chain Guard

- Material: PC
- Finish: Gloss



INNER DIAMETER SPEC.

MODEL	MIDDLE HOLE DIAMETER
CG-1331	ø80mm
CG-1332	ø102mm
CG-1333	ø112mm
CG-1334	ø120mm

SW-CG-173B Chain Guard

- Material: PC
- Finish: Gloss

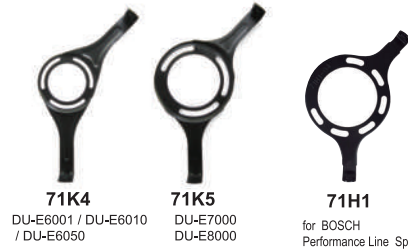

SW-773(7732) Chain Guard

- Material: PC
- Finish: Gloss
- SW-773: Inner ø155mm.
- SW-7732: Inner ø102mm.



SW-7734

SW-799 Chain Guard

- Material: PC
- Finish: Gloss
- Innr Diameter Choice: ϕ 130mm / ϕ 170mm / ϕ 190mm / ϕ 212mm.



SW-CG-133A Chain Guard

- Material: PC
- Finish: Etched



INNER DIAMETER SPEC.

MODEL	MIDDLE HOLE DIAMETER
CG-1331A	ϕ 80mm
CG-1332A	ϕ 102mm
CG-1333A	ϕ 112mm
CG-1334A	ϕ 120mm

SW-CG-131 Chain Guard

- Material: PC
- Finish: Gloss
- Weight: 164g



Streamline Look on Bike



71A0
BB Bracket



SW-CG-153 Chain Guard

- Material: Aluminum
- Finish: Coated / Anodized



Customizable Service



71H3
M333.250
(M410)



SW-772(7724) Chain Guard

- Material: PC
- Finish: Gloss
- SW-772: Inner ϕ 150mm / Max. Crank Fit: 50T.
- SW-7724: Max. Crank Fit: 48T.



SW-7724

SW-777 Chain Guard

- Material: PC
- Finish: Gloss



SW-761 Chain Guard

- Material: PC
- Finish: Gloss



SW-CG-135 Chain Guard

- Material: PC
- Stylish look on BOSCH SYSTEM .



Bracket For CG-135
Material: SUS 304



M5*10mm M5*18mm

SW-CX-111A Universal Aluminum Chain Guard

- Material: Aluminum / PC
- Designed for Road-bike (52T) and MTB (44T).
- Universal strap to fit all sizes/shapes of Down-tubes and Seat-stays.
- L 515~585 x W 160 x H 40 mm / Weight: 180g.
- Finish: Ano Silver w / sandblast



Stylish Look



Universal Down-tube Strap



Universal Seat-stay Strap

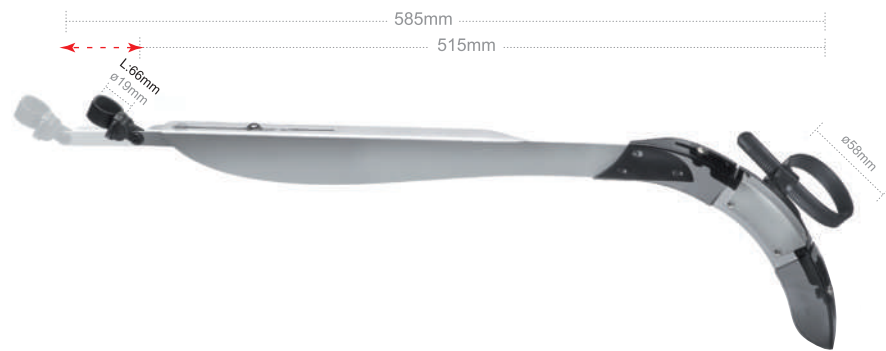

MTB 44T Road 52T
Universal Brackets

SW-CF-513 Aluminum Chain Guard

- Material: Aluminum
- Finish: Ano Matt BK



CF-513
BB Bracket



70C Seat Stay Clamp

- 70C1 ø1/2" (12.7mm)
- 70C2 ø5/8" (15.8mm)
- 70C3 ø3/4" (19mm)
- 70C4 ø7/8" (22mm)

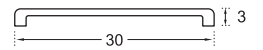

SW-CG-151 Chain Guard

- Material: PC / ABS
- Finish: Gloss
- Stylish look on bike.



Decorative Reflector



Decorative Reflector

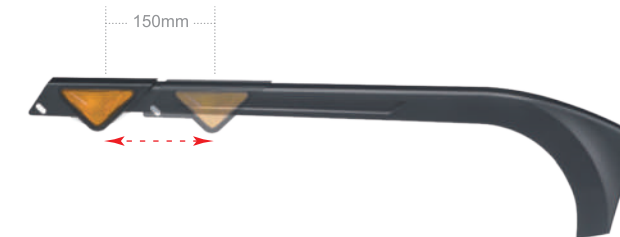

70C Seat Stay Clamp

- 70C1 ø1/2" (12.7mm)
- 70C2 ø5/8" (15.8mm)
- 70C3 ø3/4" (19mm)
- 70C4 ø7/8" (22mm)

788 CLAMPS



SW-CG-171 SHIMANO motor top cover

- Material: PC
- Stylish look on SHIMANO.
- Finish: Coated Matt BK



Front Chain Guards



Rear Chain Guards



M4*10mm

SW-70A BB / Bracket Spacer

- Material: Aluminum
- Threaded ring to ensure BB clamp is well fixed to BB.
- Available Size: $\varnothing 35 \times 40 \times 1.5\text{mm}$.
- $\varnothing 35 \times 40 \times 2.64\text{mm}$.



SW-788 Series

- Material: PP
- Finish: Gloss
- Exclusive for BMX.



788 CLAMPS



$\varnothing 25.4\text{mm}$



$\varnothing 28.6\text{mm}$



$\varnothing 31.8\text{mm}$



$\varnothing 35\text{mm}$



$\varnothing 38.1\text{mm}$



SW-788

- Fit within 44T.
- Length: 330mm.



SW-788A

- Fit within 28~36T.
- Length: 330mm.



SW-788C

- Fit within 23~28T.
- Length: 335mm.



SW-788D

- Fit within 36~44T.
- Length: 450mm.



SW-788E

- Fit within 32~44T.
- Length: 406mm.

SW-70C Seat-stay Clamp

- Material: PA
- 70C1:** fit $\phi 1/2"$ (12.7mm)
- 70C2:** fit $\phi 5/8"$ (15.8mm)
- 70C3:** fit $\phi 3/4"$ (19mm)
- 70C4:** fit $\phi 7/8"$ (22mm)



SW-70G(G1/G2) Universal Seat-stay Strap

- Material: PA
- 70G1:** $\phi 12.7\text{mm} \sim \phi 25.4\text{mm}$
- 70G2:** $\phi 19\text{mm} \sim \phi 65\text{mm}$



Universal Seat-stay Strap



SW-70D(D1/D2/D3) Chain-stay Clamp

- Material: ED Steel
- Fit $\phi 1/2" \sim 7/8"$ chain stay.
- SW-70D:** for single or multi-speed chainguards.
- SW-70D1:** for multi-speed and SHIMANO Megarange freewheel chainguards.
- SW-70D2:** fit all tubes ($\phi 17 \sim \phi 23.2\text{mm}$).
- SW-70D3/D3-1~4:** Chain stay must have M5 screw hole.



SW-70D3 Series

SW-70D3 Series



SW-AP-111 Spoke Protector

- Material: ABS
- Prevents spokes from getting damaged.
- Not suitable for Campagnolo hubs.



For Cassette Freehub



130mm



SW-AP-115 Spoke Protector

- Material: ABS
- Prevents spokes from getting damaged.



For Threaded Hub



136.5mm



SW-AP-113 Spoke Protector

- Material: ABS
- Prevents spokes from getting damaged.
- Not suitable for Campagnolo hubs.



For Cassette Freehub



152mm



SW-AP-135 Spoke Protector

- Material: ABS
- Clip-mounted to prevent spokes from getting damaged.
- Not suitable for Campagnolo hubs.



For Spoke Fitting



162mm



SW-CE-111 Bicycle Clip-On Chain Cover

- Material: POM
- Fit 1/2" x 1/8" Single Speed Bike
- Easy clip on chain.
- This Bicycle clip-on chain cover can be installed on general type except quick release chain.



Customization Colour Available



Flexible On Chain



11.4mm
13.6mm



Packaged Size:
L 112 x W 37 x H 183mm,
Qty:120pcs per pack.

STANDARD COLOUR TABLE



SW-DG-115 Dress-guard

- Material: PC / PP (clip)
- Clip to fit 26" / 700C bikes.
- Light-weight with maximized protection.
- For All Plastic-made and FA-513 Aluminum Fender.



Max Protection



Seat-stay Brackets

L ø19~22.2mm

M ø15.8mm

S ø12.8mm



Packaged Size:
L 450 x W 25 x H 210mm.