

SEAT POST CLAMPS

<p>QR Quick-release "Clip-in" Clamp</p>  <p>To fit $\varnothing 18.5 - 22.2$ mm seat post. (Exclusively made for SW-669R)</p>	<p>SW-64A2 Hinged Clamp</p>  <p>To fit $\varnothing 25 - 32$ mm seat post.</p>	<p>SW-64F2 (Standard)</p>  <p>To fit $\varnothing 25 - 32$ mm seat post.</p>	<p>SW-64F3 Clamp</p>  <p>To fit $\varnothing 32 - 40$ mm seat post.</p>
<p>SW-64D2 Clamp with Fixed Bridge</p>  <p>To fit $\varnothing 25 - 32$ mm seat post.</p>	<p>SW-64H2 Quick-release "Strap" Clamp</p>  <p>To fit $\varnothing 25 - 38$ mm seat post.</p>	<p>SW-64H3 Quick-release "Adjustable" Clamp with plastic screw</p>  <p>To fit $\varnothing 25 - 38$ mm seat post.</p>	<p>SW-64H3-1 Quick-release "Adjustable" Clamp with plastic screw</p>  <p>To fit $\varnothing 25 - 38$ mm seat post.</p>
<p>SW-64H5 Quick-release "Strap" Clamp with Rubber</p>  <p>To fit $\varnothing 25 - 38$ mm seat post.</p>			

Extension Connector

<p>64C1 (Standard) Length: 70 mm.</p> 	<p>64C2 Length: 100 mm.</p> 	<p>64C3 Length: 130 mm.</p> 	<p>64C4 Length: 70 mm.</p> 	<p>64C5 Length: 100 mm.</p> 
--	--	--	--	--

MUDGUARD CONNECTOR & BRACKETS

SB1 Inner Head-tube Connector
To fix with DHKA and/or DHKB brackets.
Head tube $\varnothing 18.5 - 22.2$ mm / $\varnothing 22.2 - 25.4$ mm



STEP 1 **STEP 2** **STEP 3**



DHKA / DHKB Front Brackets
To connect with Down-hill front fender S and/or L.
(Compatible also with SB1)



H5x8

J1 Front Bracket
To fix to the front of uni-crown fork.
(For 18" ~ 26" bikes)



J3 Rear Bracket
To fix to seat stay bridge with caliper or V-brakes.



116°

J2 Bracket
To fix to the rear of uni-crown fork or on seat stay bridge without brake.
Angle 116°
(For 18" & 20" bikes)



108°

J4 Bracket
To fix to the rear of uni-crown fork or on seat stay bridge without brake.
Angle 108°
(For 20", 24" & 26" bikes)





SB1-D Inner Head-tube Connector
For SW-FI-661NF / 669F1 / 669NF / 671NF / 133F / 135F / 153F
Head tube $\varnothing 18.5 - 34.5$ mm



SB5-01 Inner Head-tube "Quick-release" connector
(Fit inner diameter $\varnothing 18.5 / 22.2 / 25.4 / 31.8 - 34.5$ mm)
For SW-661NF / SW-669F1 / SW-669NF / SW-671NF

LOCK



SB113 Inner Head-tube Connector
Head tube $\varnothing 22.2$ mm / $\varnothing 18.5 - 22.2$ mm / $\varnothing 22.2 - 25.4$ mm / $\varnothing 31.8 - 34.5$ mm (D)



TOOL FREE

STEP 1 **STEP 2** **STEP 3**





SB9 Inner Head-tube Connector
For SW-FI-155FR-A / SW-FI-155F/R-B
Head tube $\varnothing 18.5 - 34.5$ mm



SW-663F(FN)/CR(HR) Quick-release Mudguard

- Material: PP
- SW-663F front mudguard with rubber strap to quickly wrap on any fork.
- SW-663FN front mudguard with stainless steel connector.
- SW-663CR rear mudguard with 64F2 fixed clamp to fit $\varnothing 32 \sim 40\text{mm}$ seat-post.
- SW-663HR rear mudguard with 64H2 quick-release clamp to fit $\varnothing 25 \sim 38\text{mm}$ tubes.
- Lightweight and durable.
- Rear mudguard angle adjustable.



SW-670F(QF)/R(QR) Quick-release Mudguard

- Material: PP
- SW-670F/R combined with 67S1F stainless steel connector.
- SW-670QF/QR combined with 67Q1F stainless steel connector.
- Quick setup and release to fork sleeve.
- Lightweight and durable.
- SW-6705L bracket designed for Shimano BR 5800 Dual pivot system.

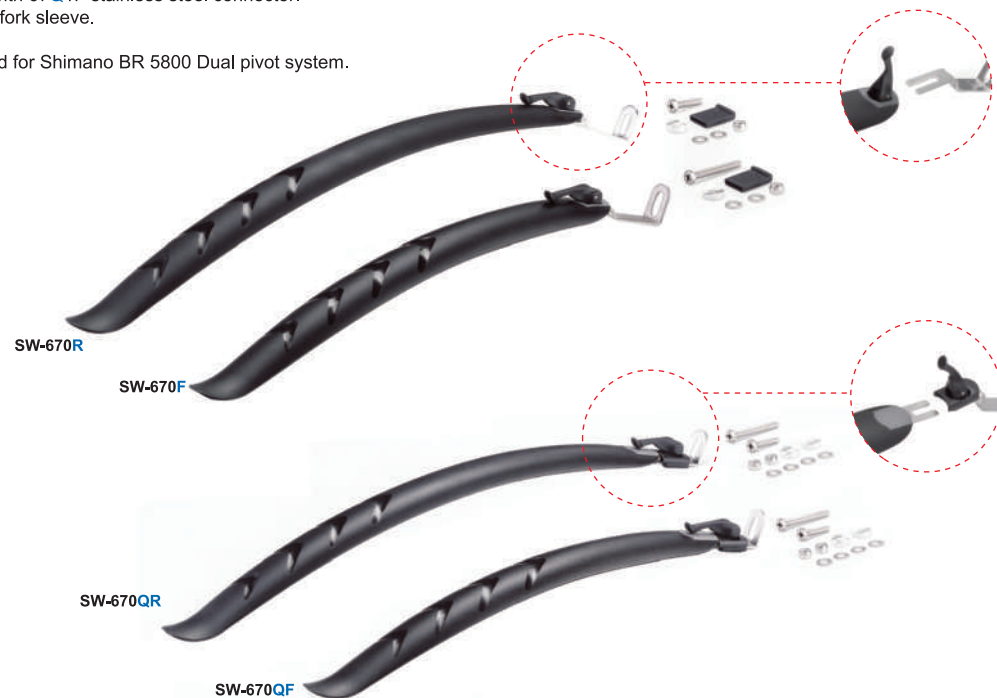

SW-6705L
Designed for Shimano BR 5800 Dual pivot system.

FENDER STAY MOUNTING (FIXED)

SELECTIVE STAY THICKNESS
All fender stay are available in $\varnothing 3.2\text{mm}$ and $\varnothing 4.0\text{mm}$ thickness to meet different needs.

Material: • 204 / 304 (Natural, ED): $\varnothing 3.2$ and $\varnothing 4.0\text{mm}$
• Steel (CP, ED): $\varnothing 4.0\text{mm}$

SELECTIVE STAY EYELET DIAMETER

 $\varnothing 5\text{mm}^{+0.3}_{-0.1}$	 $\varnothing 6\text{mm}^{+0.3}_{-0.1}$	 $\varnothing 8\text{mm}^{+0.3}_{-0}$	 $\varnothing 10\text{mm}^{+0.3}_{-0.1}$
--	--	--	---

MSB
FENDER STAY + SAFETY QR FASTENER 804N
Fender stay mounted to the interior of fenders with SW-804N under bracket.
For SW-FI-151FR / SW-FI-171FR / SW-FI-173FR / SW-FI-175FR / SW-FI-117FR

POI
SINGLE-STAY + SAFETY QR FASTENER
Widely used for front fender installation.
Stay accompanies selective QR fastener: (POPOFF5)

POV
V-STAY + SAFETY QR FASTENER
For both front and rear fender installation.
Stay accompanies selective QR fastener: (POPOFF5)
*stand $\varnothing 40$

POP OFF 5
SAFETY QR FASTENER (For $\varnothing 3.2 / \varnothing 4$ mm FENDER-STAY)
Material: POM
Safety design to detach in accident and prevent jamming the wheel.
(QR) quick release, easy installation and allows 20mm stay length adjustment.

FENDER STAY HARDWARE

804N Pat.
Easy installation
Polyester nameplate
Fit $\varnothing 4\text{mm}$ fender stay.
For SW-FI-151FR / SW-FI-171FR
SW-FI-173FR / SW-FI-175FR
SW-FI-117FR

804N-01
Material: TPR
Pad underneath the 804N
in order to fit curved surface.

Optional
Color: BLACK

FENDER STAY SAFETY POP-OFF

STAY SAFETY	MODEL	FIT STAY	STAY
 POP OFF5	SAFETY QR FASTENER (For $\varnothing 3.2 / \varnothing 4$ mm FENDER-STAY) INJECTED FENDER ONLY Safety design to detach in accident and prevent jamming the wheel. (QR) quick release, easy installation and allows 20mm stay length adjustment. Designed for : SW-655, SW-656, FI-117, FI-173, SW-615, SW-668, FI-111, FI-171	POI POV	 Auto-detach When Jammed
	FV-515 Patented FENDER STAY SAFETY POP-OFF Applicable to MSB fender-stays to pop-off when jammed.	MSB	

SW-FI-157 Down-tube Mudguard (For Road-bike)

- Material: PP / TPR
- Soft TPR material to fit different shape of down-tubes.
- Special buckle with Velcro-tie fixation for easy installation and release.



Design for Roadbike



Special buckle fixation

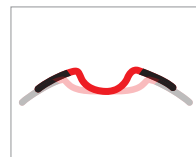

Elastic material to fit all tubes

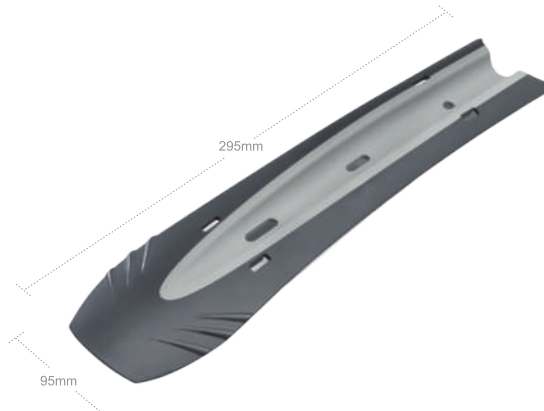

Packaged Size:
L 710 x W 200mm.

SW-PS1F/R Refoldable Quick-release Mudguard

- Material: PA6



"Clip-in" Front Mudguard

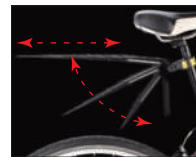

Adjustable Rear Mudguard



Safety Reflective Stickers

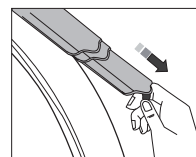

Refoldable Design

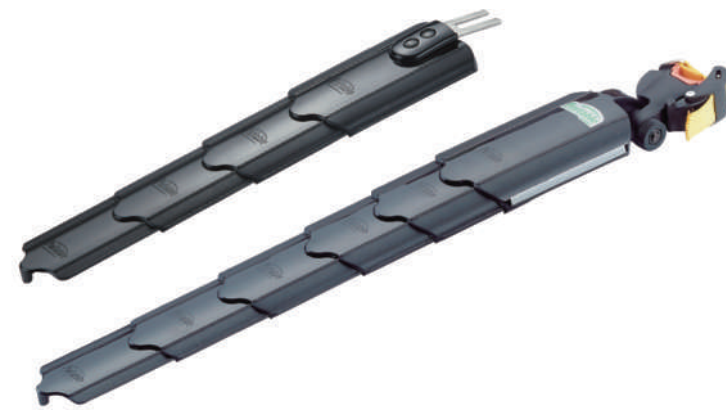

FRONT MUDGUARD FIX

(Standard)
SW-S1
Fix to the BACK of fork sleeve

SW-67S1F
Fix to the FRONT of fork sleeve

SW-SB1
Fix to the INSIDE of steer tube

SW-FI-119F(F1)/R(R1) Quick-release Mudguard

- Material: PP
- Minimal design to suit all style of bikes.
- Effective mud stop.
- Easy installation.
- Tough and durable.
- Optional SW-FI-119F1/R1 with wider mudguard-tail.



Front Fender



Rear Fender



SW-FI-119F/R



FI-119F/R Mudguard Tail



FI-119F1/R1 Mudguard Tail



SW-FI-119F1/R1
(Wider mudguard-tail)

SW-FI-131CR(HR) Quick-release Mudguard

- Material: PP
- Minimal design to suit all style of bikes.
- Effective mud stop.
- Easy installation.
- Tough and durable.
- FI-131CR with 64F2 fixed clamp to fit $\varnothing 25 \sim 32$ mm seat-post.
- FI-131HR with 64H2 quick-release clamp to fit $\varnothing 25 \sim 38$ mm tubes.

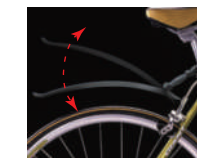

Rear Mudguard



SW-FI-131CR

SW-FI-131HR



64F2
Fixed Clamp
• Fit $\varnothing 25 \sim 32$ mm seat-post.



64H2
Quick-release "Strape" Clamp
• Fit $\varnothing 25 \sim 38$ mm seat-post.



64H3 64H3-1
Quick-release "Adjustable" Clamp
with Plastic Screw
• Fit $\varnothing 25 \sim 38$ mm seat-post.



QR Slide-release Clamp
• Fit $\varnothing 25 \sim 32$ mm seat-post.
64H5 Quick-release "Strape" Clamp
• Fit $\varnothing 25 \sim 38$ mm seat-post.

SW-DH7 Down-hill Mudguard

- Material: PP
- Aerodynamic design.
- Effective over-width mud stop.
- Easy installation.
- Tough and durable.



Front Mudguard



Rear Mudguard



SW-613F/R Mudguard

- Material: PP
- Fit uni-crown fork Cantilever brake style.
- Fit $\phi 28.6 \sim \phi 31.8$ mm seat-tube.
- Slide in and fix.



Front Mudguard



Rear Mudguard



SW-613 Slide-fix Hanger

SW-DH5 Down-hill Mudguard

- Material: PP
- Muscular look.
- Easy installation.
- Tough and durable.
- Widest combination to fit from 16" ~ 26" bikes.



DHKA + DHKB



SW-DH5L+S
Fit $\phi 18.5 \sim 25.4$ mm Inner Stem



SW-64A2



Fit $\phi 25 \sim 32$ mm Seat Post



SW-64D2



Fit $\phi 25 \sim 32$ mm Seat Post
w/ Built-in Clamp on Bridge

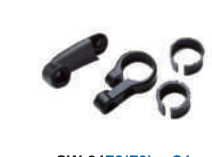

SW-64F2(F3) + C1



SW-64F2 - Fit $\phi 25 \sim 32$ mm
SW-64F3 - Fit $\phi 32 \sim 40$ mm



SW-64H2(H3) + C2

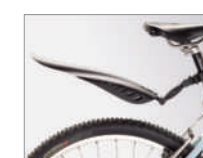

Fit $\phi 25 \sim 38$ mm Seat Post

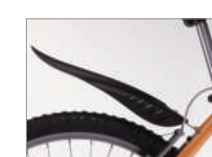

SW-DH5R - with J3 Bracket
to Fit on Seat-stay Bridge



SW-DH5L+S
with J1 & J4 Brackets
to Fit on Uni-crown Fork



J1~J4 Brackets for DH5

Wheel Size	Mudguard Selection	Fitting
12"	DH5T	
16"	DH5S+T	Fit on seat post (Rear Mudguard)
20"	DH5R	Fit on bridge (Rear Mudguard)
	DH5L	
	DH5S	Front Mudguard
24"~26"	DH5L+S+R	Front & Rear Mudguards

SW-651F/R Mudguard

- Material: PP
- Tough, durable and effective mud stop.
- Selective hardware for variety of bikes.
- Hardware bendable to fit.



Front Mudguard



Rear Mudguard



SW-651 REAR MUDGUARD HARDWARE

• Material: ED Steel



- Standard**
- Fit rear cantilever brake.
 - Mount bridge or bridge-plate.
 - Fit ATB recommended.



- SW-651-V1**
- Fit rear cantilever / long arm V-brake.
 - Mount bridge or bridge-plate.



- SW-651-V3 / 659**
- Fit rear V-brake.
 - Mount bridge or bridge-plate.



- SW-651-D1**
- Fit rear drum brake.
 - Mount bridge or bridge-plate.



- SW-651-L1**
- Fit side lock bikes only.
 - Mount bridge or bridge-plate.

SW-654(640)F/R Mudguard

- Material: PP
- For full-suspension XC bikes.
- Angle adjustable rear mudguard hardware.
- Front mudguard length adjustable.



Front Mudguard



Rear Mudguard

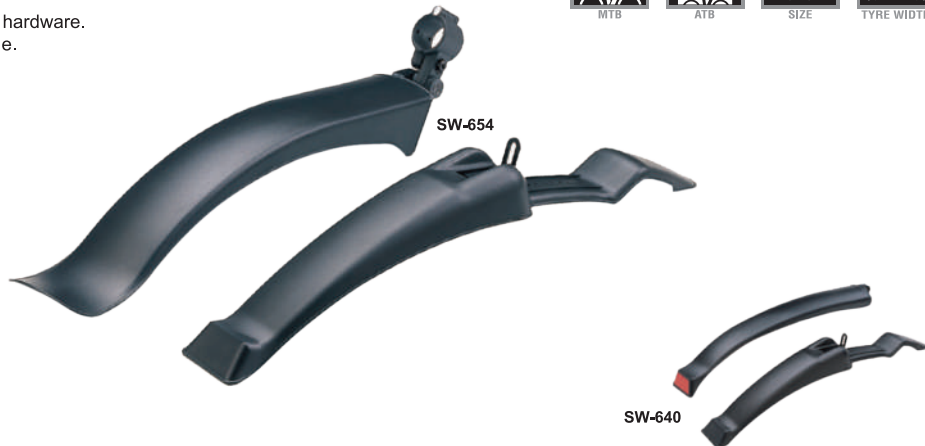

Front Mudguard Hanger



- SW-640 Slide-fix Hanger**
- Material: ED Steel
 - Fit uni-crown fork with Cantilever & V-brake.
 - Slide-in and fix.
 - 4-position adjustable.

Rear Mudguard Seat Post Bracket



- SW-64A2**
- Hinged clamp for ø25 ~ 32mm seatpost.



- SW-64D2**
- Hinged clamp for ø25 ~ 32mm seatpost.

- SW-64F2 / SW-64F3**
- SW-64F2: ø25~32mm clamp Mounting on seat post
 - SW-64F3: ø32~40mm clamp Mounting on seat post.

SW-641F/R Mudguard

- Material: PP
- Fit uni-crown fork Cantilever brake style.
- Fit ø28.6 ~ ø31.8mm seat-tube.
- Slide in and fix.
- 4 position adjustable.



Front Mudguard



Rear Mudguard



SW-616 Slide-fix Hanger

SW-642F/R(RL) Mudguard

- Material: PP
- Angle adjustable rear mudguard hardware SW-64A2 to fit ø25~32mm seat post.
- Optional SW-642RL extendable rear mudguard for better mud stop.



Front Mudguard



Rear Mudguard



Extendable Rear Mudguard



SW-642RL

SW-669CR Quick-release Mudguard

- Material: PP
- Angle adjustable.
- Optional 64C series mudguard bridge.



Rear Mudguard



Selective Color (MOQ: 500sets)



64F2
Fixed Clamp

- Fit $\varnothing 25 \sim 32$ mm seat-post.



QR
Slide-release Clamp

- Fit $\varnothing 25 \sim 32$ mm seat-post.



64H2
Quick-release "Strape" Clamp

- Fit $\varnothing 25 \sim 38$ mm seat-post.



64H5
Quick-release "Strape" Clamp

- Fit $\varnothing 25 \sim 38$ mm seat-post.



64H3 Quick-release "Adjustable" Clamp with Plastic Screw

- Fit $\varnothing 25 \sim 38$ mm seat-post.

SW-669F1/R1 Quick-release Mudguard

- Material: PP
- Suitable for suspension fork.



Easy to install with SB1-D

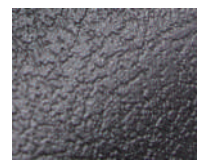

Leather Texture



Front Mudguard



Rear Mudguard



64F2
Fixed Clamp

- Fit $\varnothing 25 \sim 32$ mm seat-post.



64H2
Quick-release "Strape" Clamp

- Fit $\varnothing 25 \sim 38$ mm seat-post.



64H3 Quick-release "Adjustable" Clamp with Plastic Screw

- Fit $\varnothing 25 \sim 38$ mm seat-post.

SB1-D Exclusive Hardware

- Click fix on the BOTTOM of inner head tube.

Use Head tube(mm)	SB1-D	SB1-D	SB1-D	SB1-D
$\varnothing 22.2$	•			
$\varnothing 25.4$	•	•		
$\varnothing 28.6$	•		•	
$\varnothing 31.8$	•			•
$\varnothing 34.5$	•	•		•

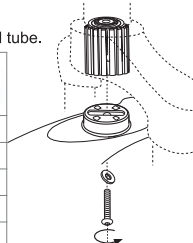

SB5-01
Exclusive Hardware

- Click fix on the BOTTOM of inner head tube.
- Fit $\varnothing 18.5 \sim 22.2$ mm / $\varnothing 22.2 \sim 25.4$ mm / $\varnothing 31.8 \sim 34.5$ mm.

SW-655F/R(R1/RL) Mudguard

- Material: PP
- Fit uni-crown fork Cantilever & V-brake.
- Cable-friendly seat-tube clip design.
- Fit 5/8" or 1/2" seat-stay bridge.
- Cable-friendly clip to fit $\varnothing 28.6 \sim 31.8$ mm seat tube.
- Mud-flap design for better mud stop.
- Optional SW-655R1 (without steel clip) and SW-655RL (Larger mud-flap) rear mudguard.



Easy-release Knob



Front Mudguard



Cable-friendly Seat-tube Clip



Rear mudguard



SW-655R

SW-655F

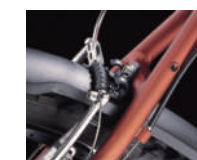

2-way Mudguard Bracket



OPTIONAL

POP OFF5

SAFETY QR FASTENER INJECTED FENDER ONLY
Safety design to detach in accident and prevent jamming the wheel.



SW-655RL (Larger TPR mud-flap)



SW-655R1 (without steel clip)

SW-661NF+CR Quick-release Mudguard

- Material: PP + TPR
- Suitable for suspension fork.
- Quick-release front mudguard.
- Angle adjustable rear mudguard with fixed clamp.



Easy to install with SB1-D



Front Mudguard



Rear Mudguard



64F2
Fixed Clamp

- Fit $\varnothing 25 \sim 32$ mm seat-post.



64H2
Quick-release "Strape" Clamp

- Fit $\varnothing 25 \sim 38$ mm seat-post.



SB5-01
Exclusive Hardware

- Click fix on the BOTTOM of inner head tube.
- Fit $\varnothing 18.5 \sim 22.2$ mm / $\varnothing 22.2 \sim 25.4$ mm / $\varnothing 31.8 \sim 34.5$ mm.

64H3 Quick-release "Adjustable" Clamp with Plastic Screw

- Fit $\varnothing 25 \sim 38$ mm seat-post.



64H5
Quick-release "Strape" Clamp

- Fit $\varnothing 25 \sim 38$ mm seat-post.

SB1-D Exclusive Hardware

- Click fix on the BOTTOM of inner head tube.

Use Head tube(mm)	SB1-D	SB1-D	SB1-D	SB1-D
$\varnothing 22.2$	•			
$\varnothing 25.4$	•	•		
$\varnothing 28.6$	•		•	
$\varnothing 31.8$	•			•
$\varnothing 34.5$	•	•		•

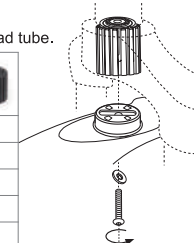

SW-1001 Down-tube Mudguard

- Material: PP / ABS
- Selective fix types:
SW-1001A: Pre-bolted fix.
SW-1001C: Rubber tie fix.
- Quick and easy setup.
- Lightweight and durable.



A Pre-bolted



C Rubber Tie



SW-1001T

- For pre-bolted down tubes only.



SW-1001S

- For pre-bolted down tubes only.



FI-113F Quick-release Mudguard (match to sw-669R)

- Material: PP
- Multiple Color Selection
- 4-position Adjustable (17.5mm)



Front Mudguard



SB-113
Exclusive Hardware

- Click fix on the BOTTOM of inner head tube.
- Fit $\phi 18.5 \sim 22.2\text{mm}$ / $\phi 22.2 \sim 25.4\text{mm}$ / $\phi 31.8 \sim 34.5\text{mm}$.

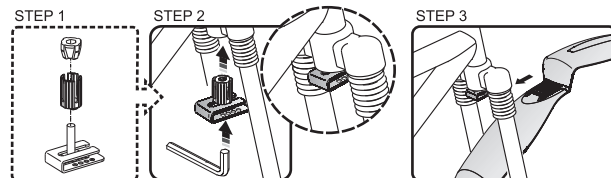

SW-669NF Quick-release Mudguard

- Material: PP



Front Mudguard



SB5-01
Exclusive Hardware

- Click fix on the BOTTOM of inner head tube.
- Fit $\phi 18.5 \sim 22.2\text{mm}$ / $\phi 22.2 \sim 25.4\text{mm}$ / $\phi 31.8 \sim 34.5\text{mm}$.

SB1-D Exclusive Hardware

- Click fix on the BOTTOM of inner head tube.

Use Head tube(mm)				
$\phi 22.2$	•			
$\phi 25.4$	•	•		
$\phi 28.6$	•		•	
$\phi 31.8$	•			•
$\phi 34.5$	•	•		•

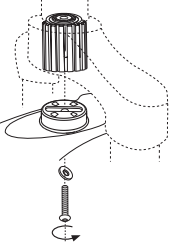

SW-671NF/HR Quick-release Mudguard

- Material: PP + TPR
- Suitable for suspension fork.



Easy to install with SB1-D



Soft Tail for Safety



Front Mudguard



Front Mudguard



64F2
Fixed Clamp

- Fit $\phi 25 \sim 32\text{mm}$ seat-post.



64H2
Quick-release "Strape" Clamp

- Fit $\phi 25 \sim 38\text{mm}$ seat-post.



64H3
Quick-release "Adjustable" Clamp with Plastic Screw

- Fit $\phi 25 \sim 38\text{mm}$ seat-post.

64H3-1



64H5
Quick-release "Strape" Clamp

- Fit $\phi 25 \sim 38\text{mm}$ seat-post.

SB1-D Exclusive Hardware

- Click fix on the BOTTOM of inner head tube.

Use Head tube(mm)				
$\phi 22.2$	•			
$\phi 25.4$	•	•		
$\phi 28.6$	•		•	
$\phi 31.8$	•			•
$\phi 34.5$	•	•		•

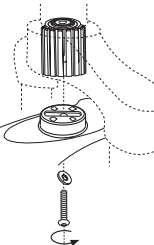

SB5-01
Exclusive Hardware

- Click fix on the BOTTOM of inner head tube.
- Fit $\phi 18.5 \sim 22.2\text{mm}$ / $\phi 22.2 \sim 25.4\text{mm}$ / $\phi 31.8 \sim 34.5\text{mm}$.

SW-FI-137 Series Quick-release Mudguard

• Material: PP



Fixation Type



Pre-bolted



Rubber Tie



Carbon Sticker (PP)



Double-Injection (PP / TPR)



Double-Injection with Logo (PP / TPR)

SW-FI-151F/R Mudguard

- Material: PP
- Fit uni-crown fork Cantilever brake style.
- Fit $\varnothing 28.6 \sim \varnothing 31.8$ mm seat-tube.
- Slide in and fix.
- 4 position adjustable.



Seat-tube Clamp



Front Mudguard



Rear Mudguard



60mm



804N
Easy installation
Polyester nameplate
Fit $\varnothing 4$ mm fender stay.



SW-FI-117F/R Mudguard

- Material: PP
- Length adjustable up to 25mm.
- 2 sizes of clamps included for $\varnothing 28\sim 32$ mm & $\varnothing 32\sim 36$ mm seat-tubes.



Length Adjustable +25mm



Seat-tube Clamp



Front Mudguard



Rear Mudguard



66mm



SW-FI-133F/R Quick-release Mudguard

- Material: PC
- Available color: Black / Smoky / White.



Easy to install with SB1-D



Front Mudguard



Easy to install with 64H3-A



with Carbon Sticker



Mudguard Angle Adjustable



Bridge Angle Adjustable



SB1-D Exclusive Hardware

- Click fix on the BOTTOM of inner head tube.

Use Head tube(mm)	SB1-D	SB5-01	SB5-02	SB5-03
$\varnothing 22.2$	•			
$\varnothing 25.4$	•	•		
$\varnothing 28.6$	•		•	
$\varnothing 31.8$	•			•
$\varnothing 34.5$	•	•		•

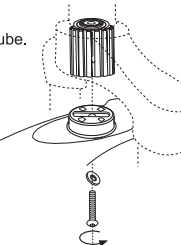

SB5-01
Exclusive Hardware

- Click fix on the BOTTOM of inner head tube.
- Fit $\varnothing 18.5 \sim 22.2$ mm $\varnothing 22.2 \sim 25.4$ mm / $\varnothing 31.8 \sim 34.5$ mm.

SW-FI-177F/R Mudguard

- Material: PP
- Fit uni-crown fork Cantilever brake style.
- Fit ø28.6 ~ ø31.8mm seat-tube.
- Slide in and fix.
- 4 position adjustable.



Seat-tube Clamp



Front Mudguard



Rear Mudguard



SW-FI-151F/RL Mudguard

- Material: PP / TPR
- Fit uni-crown fork Cantilever brake style.
- Fit ø28.6 ~ ø31.8mm seat-tube.
- Slide in and fix.
- 4 position adjustable.



Seat-tube Clamp



Front Mudguard



Rear Mudguard



SW-FI-153F/R Quick-release Mudguard

- Material: PP+TPR
- Special soft material to provide better safety
- Front-mudguard fit up to ø34.5mm inner Head-tube
- Rear-mudguard fit up to ø32mm Seat-post
- **FI-153F**: L 500 x W 75 x H 85 mm / 65g.
- **FI-153R**: L 550 (590 extended) x W 90 x H 120 mm / 185g.



Easy to install with SB1-D



Front Mudguard



Tool-free Rear Clamp



Angle Adjustable



Bridge Length Adjustable
Four adjusting points



Customizable Logo Plate



SB1-D Exclusive Hardware

- Click fix on the BOTTOM of inner head tube.

Use Head tube(mm)	SB1-D	SB5-01	SB5-02	SB5-03
ø22.2	•			
ø25.4	•	•		
ø28.6	•		•	
ø31.8	•			•
ø34.5	•	•		•

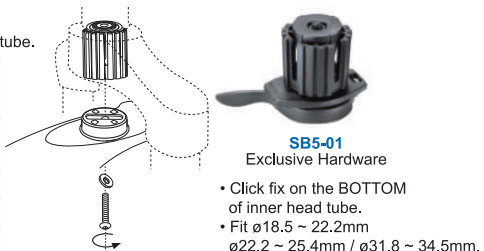

SW-FI-159 Mudguard

- Material: PP / TPR
- Soft TPR material to fit different shape of down-tubes.
- For aggressive ride.



Pre-bolted

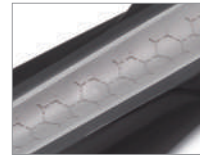

Anti-slip design

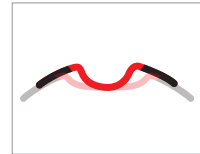

Elastic material to fit all tubes



SW-FI-173 F/R Mudguard

- Material: PP
- Fit 650B~29" Mountain-bikes.
- Slide in and fix.



Seat-tube Clamp



Front Mudguard



Rear Mudguard



Slide-fix Hanger
FI-171R / FI-171F

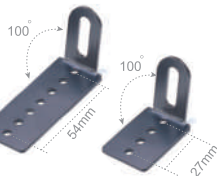

OPTIONAL
POP OFF5

**SAFETY QR FASTENER
INJECTED FENDER ONLY**
Safety design to detach in accident
and prevent jamming the wheel.

804N
Easy installation
Polyester nameplate
Fit ø4mm fender stay.



SW-FI-155F/R-A Quick-release Mudguard

- Material: PP
- Quick-release design on front mudguard to fit ø18.5 ~ 34.5mm Inner Head-tube.
- Length adjustable, 3-position rear bridge to fit up to 29" wheel.
(30mm adjusting range, 15mm for each position)
- Best coverage for maximum mud stop effect.



Front Mudguard



Easy to install with SB1-D1



Angle Adjustable



Slip-proof Strap Clamp



3-Position Adjustment



30mm 3-Step Adjustment



SB1-D1 Exclusive Hardware

- Click fix on the BOTTOM of inner head tube.

Use Head tube(mm)	Use	Use	Use	Use
ø22.2	•			
ø25.4	•	•		
ø28.6	•		•	
ø31.8	•			•
ø34.5	•	•		•

Packaged Size:
L 670 x W 114mm.

SW-FI-155F/R-B Quick-release Mudguard

- Material: PP
- Quick-release design on front mudguard to fit ø18.5 ~ 34.5mm Inner Head-tube.
- Length adjustable, twist-knob rear bridge to fit up to 29" wheel.
(40mm free adjusting range)
- Best coverage for maximum mud stop effect.



Front Mudguard



Easy to install with SB1-D1



Angle Adjustable



Slip-proof Strap Clamp



Twist-knob Adjustment



40mm Free Adjustment



SB1-D1 Exclusive Hardware

- Click fix on the BOTTOM of inner head tube.

Use Head tube(mm)	Use	Use	Use	Use
ø22.2	•			
ø25.4	•	•		
ø28.6	•		•	
ø31.8	•			•
ø34.5	•	•		•

Packaged Size:
L 660 x W 114mm.

SW-FX-119D Quick-release Mudguard (Down-tube)

- Material: PP
- Fits most down-tubes.
- Mudguard graphic can be easily custom-designed.
- L 368 x W 112 x H 60 mm. / Weight: 70 g.



Packaged Size:
L 470 x W 190 x H 35 mm.

SW-FX-119R Quick-release Mudguard (Rear)

- Material: PP
- Fits up to Ø 32.5 mm seatposts.
- Angle adjustable.
- Mudguard graphic can be easily custom-designed.
- L 560 x W 114 x H 97 mm. / Weight: 200 g.



Packaged Size:
L 550 x W 190 x H 50 mm.

SW-FI-175F/R Mudguard

- Material: PP

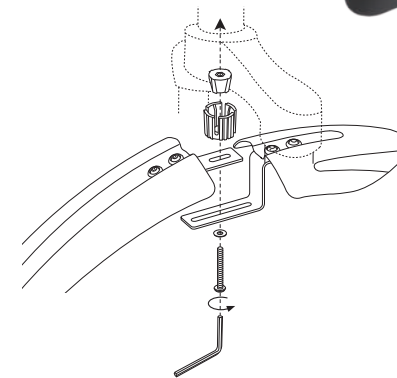
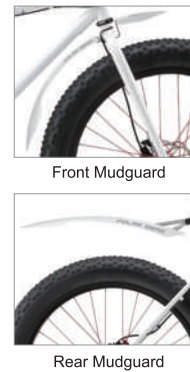

SW-FI-175D/R Down-tube Mudguard (For Snow-bike)

- Material: PP
- Rubber Tie to fit all sizes of down tubes.
- Quick and easy setup.
- Lightweight and durable.



SW-FX-119DC

Quick-release Mudguard (Down-tube)

- Material: PP
- Fits most down-tubes.
- Tool-free assembly for easier and faster installation.
- Innovative "One-piece-made" package design.
- Customizable graphic and die-cut.
- L 420 x W 140 x H 70 mm. / 93g.



Fast Install & Release



Rubber-tie Fixation



Integrated Package Design



Packaged Size:
L 585 x W 200 x H 35 mm.

SW-FX-119RC

Quick-release Mudguard

- Material: PP
- Fits up to $\varnothing 32.5$ mm seatposts.
- Angle adjustable.
- Tool-free assembly for easier and faster installation.
- Innovative "One-piece-made" package design.
- Customizable graphic and die-cut.
- Fit 24~26" wheels.
- L 614 x W 78 x H 142 mm. / 155.5g.



Tool-free Assembly



Easy to Install with 64H3



Easy Install & Release



Angle Adjustable



Integrated Package Design



Packaged Size:
L 710 x W 200 x H 35 mm.

SW-FX-119DS

Quick-release Mudguard (Down-tube)

- Material: PP
- Fits most down-tubes.
- Tool-free assembly for easier and faster installation.
- Innovative "One-piece-made" package design.
- Customizable graphic and die-cut.
- L 400 x W 120 x H 55 mm. / 80g.



Fast Install & Release



Rubber-tie Fixation



Pre-bolted Fixation



Integrated Package Design



Packaged Size:
L 565 x W 200 x H 35 mm.

SW-FX-119RS

Quick-release Mudguard

- Material: PP
- Fits up to $\varnothing 32.5$ mm seatposts.
- Angle adjustable.
- Tool-free assembly for easier and faster installation.
- Innovative "One-piece-made" package design.
- Customizable graphic and die-cut.
- Fit 26~29" wheels.
- L 573 x W 109 x H 90 mm. / 200g.



Tool-free Assembly



Easy to Install with 64H3



Easy Install & Release



Angle Adjustable



Integrated Package Design



Packaged Size:
L 638 x W 200 x H 35 mm.

SW-FI-111F/R Mudguard

- Material: PP
- Length adjustable up to 25mm.
- 2 sizes of clamps included for $\varnothing 28\sim 32\text{mm}$ & $\varnothing 32\sim 36\text{mm}$ seat-tubes.



Length Adjustable +25mm



Seat-tube Clamp



Front Mudguard



Rear Mudguard



SW-FI-171 F/R Mudguard

- Material: PP
- Fit 650B~29" City-bikes.
- Slide in and fix.
- Cable-friendly Clip to fit $\varnothing 28.6 \sim 31.8\text{mm}$ seat tube.



Seat-tube Clamp



Front Mudguard



Rear Mudguard

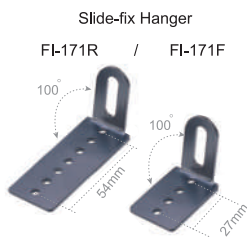

SW-668F/R Mudguard

- Material: PP
- Fit uni-crown fork Cantilever & V-brake.
- Fit $\varnothing 28.6 \sim \varnothing 31.8\text{mm}$ seat-tube.
- Fit 5/8" or 1/2" seat-stay bridge.
- Cable-friendly Clip to fit $\varnothing 28.6 \sim 31.8\text{mm}$ seat tube.



Front Mudguard



Rear Mudguard



SW-664F/R Mudguard

- Material: PP



Front Mudguard



Rear Mudguard



SW-CF-065F/R Mudguard

- Material: PP
- Front mudguard fits kid's bikes with suspension fork, v-brake and uni-crown fork.
- Slide-fix front mudguard hanger for easy installation & positioning.
- Mudguard hanger bendable for angle-adjusting.



Front Mudguard



Rear Mudguard



SW-647FS Mudguard

- Material: PP
- Fit kid's bike with uni-crown.
- Slide-fix mudguard hanger for easy installation & positioning.
- Mudguard hanger bendable for angle-adjusting.



Slide-fix Hanger



SW-FI-115F(FH)/R Quick-release Mudguard

- Material: PP
- Trendy & stylish.
- Multi-style selection.
- Effective mud stop.
- Easy installation.
- Tough and durable.
- Optional FI-115FH front mudguard with forehead.



Optional Alloy Strap



Optional Reflective Strap



Rear Mudguard



Front Mudguard



Optional Alloy / 3M Reflective Strap



SW-FI-115FH (with forehead)

SW-PS3F/PS1R Refoldable Quick-release Mudguard

- Material: PA6



"Clip-in" Front Mudguard

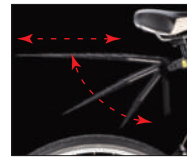

Adjustable Rear Mudguard



Safety Reflective Stickers

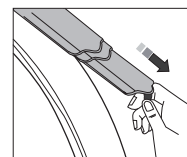

Refoldable Design



SW-FI-179A Mudguard

- Material: PP
- Finish: Etched
- Fit for ROCK SHOX front fork, [MY21_SLD_35](#).
- Easy installation & positioning by fastened on front fork.

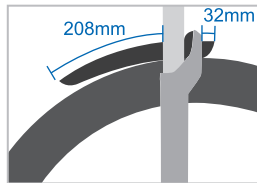

SW-FI-179B Mudguard

- Material: PP
- Finish: Etched
- Fit for ROCK SHOX front fork, [MY21_SLD_35](#).
- Easy installation & positioning by fastened on front fork.

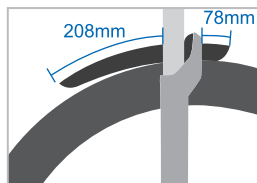

SW-650F/R Mudguard

- Material: PP
- Fit kid's bikes with uni-crown and cantilever or caliper brake style.
- Slide-fix mudguard hanger for easy installation & positioning.
- Mudguard hanger bendable for angle-adjusting.



Slide-fix Hanger



SW-651FS/RS Mudguard

- Material: PP
- Front mudguard fits kid's bikes with uni-crown fork.
- Various ED steel hardware of rear mudguard to meet different fitting needs.



Front Mudguard



Rear Mudguard



SW-651 REAR MUDGUARD HARDWARE

• Material: ED Steel

 <p>Standard</p> <ul style="list-style-type: none"> • Fit rear cantilever brake. • Mount bridge or bridge-plate. • Fit ATB recommended. 	 <p>SW-651-V1</p> <ul style="list-style-type: none"> • Fit rear cantilever / long arm V-brake. • Mount bridge or bridge-plate. 	 <p>SW-651-V3 / 659</p> <ul style="list-style-type: none"> • Fit rear V-brake. • Mount bridge or bridge-plate. 	 <p>SW-651-D1</p> <ul style="list-style-type: none"> • Fit rear drum brake. • Mount bridge or bridge-plate. 	 <p>SW-651-L1</p> <ul style="list-style-type: none"> • Fit side lock bikes only. • Mount bridge or bridge-plate.
--	--	--	---	--

SW-FI-179C Mudguard

- Material: PP
- Finish: Etched
- Fit for ROCK SHOX front fork:

SW-FI-179C:
[MY21_ZEB_38.](#)
SW-FI-179C1:
[MY21_35_35.](#)
[MY21_Recon_32.](#)

- Easy installation & positioning by fastened on front fork.

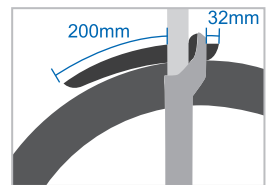

SW-FI-179D Mudguard

- Material: PP
- Finish: Etched
- Fit for ROCK SHOX front fork:

SW-FI-179D:
[MY21_ZEB_38.](#)
SW-FI-179D1:
[MY21_35_35.](#)
[MY21_Recon_32.](#)

- Easy installation & positioning by fastened on front fork.

