

P.C. FENDER PROFILE

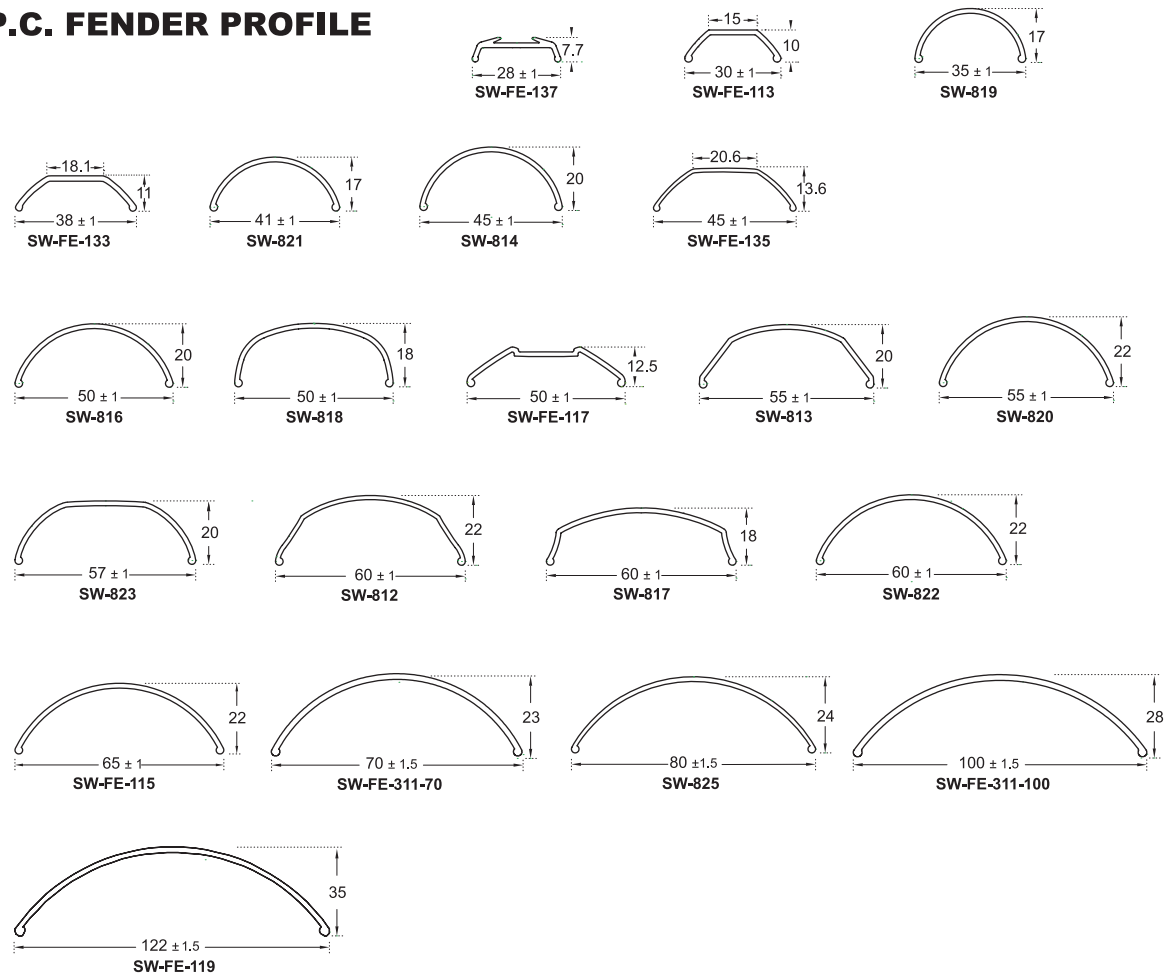

P.C. FENDER CABLE STORAGE TECH PROFILE

● ø3mm
○ ø5mm

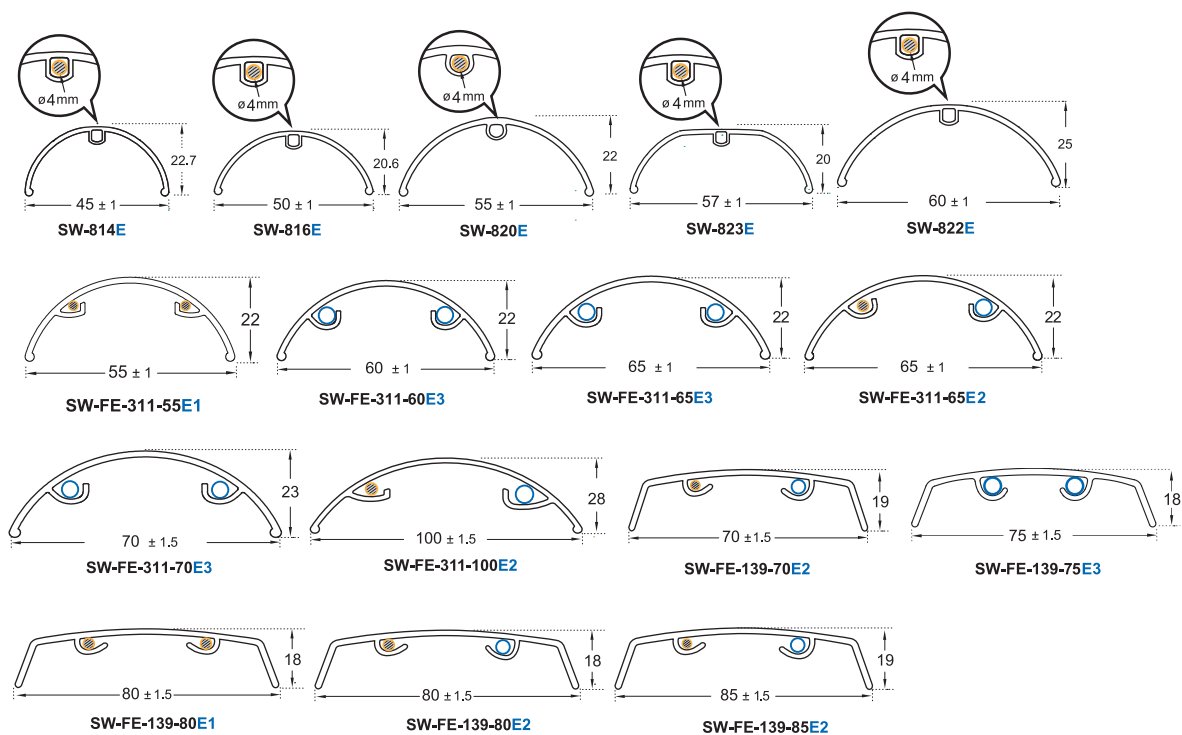

Plastic Full-cover Fender

Use of Polycarbonate (P.C.) is one of Sunny Wheel's specialty in introducing the making of lightweight full cover fenders. The density of P.C. is around 1.2, with high transparency, glossy surface and flexibility. Good resistance not only in weathering but also impact. Stable quality with minimal shrinkage. Material with such characteristics makes our plastic full cover fender your top choice.



Weatherproof from -20°C up to 130°C



Impact Resistance (-20°C)

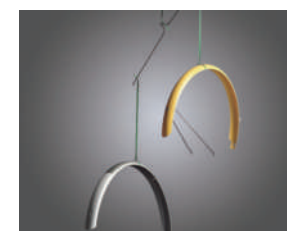



Lightweight



High Flexibility









FENDER STAY SAFETY POP-OFF

	<p>FV-515 Patented (For $\phi 3.2 / \phi 4$ mm FENDER-STAY) FENDER STAY SAFETY POP-OFF Material: PA6 Applicable to MSA / MSB / MSI / MSV fender-stays to pop-off when jammed.</p>	<p>MSA MSB MSI MSV</p>	
---	---	---	---

FENDER STAY MOUNTING (FIXED)

	<p>804N-02 UPPER-MOUNTED FENDER STAY Material: 303 Stainless</p>	
	<p>804E-1 UNDER-MOUNTED FENDER STAY Material: Zinc • $\phi 4$mm / $\phi 5$mm</p>	

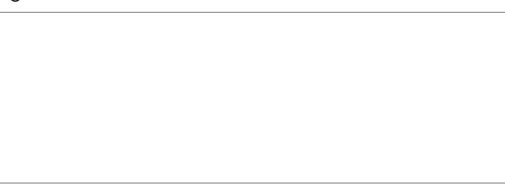
FENDER STAY / SEAT STAY HARDWARE

	<p>804H • Fender stay: $\phi 3.9$mm • Material: Steel • Finishing: ED BK</p> <p>804H-1 • Fender stay: $\phi 5.0$mm • Material: Steel • Finishing: UCP</p>	<p>12mm 20mm Prevent Rotation $\phi 5$mm screw hole 804J • Fender stay: $\phi 4.0$mm 804J-1 • Fender stay: $\phi 3.2$mm $\phi 6$mm screw hole 804J-2 • Fender stay: $\phi 5$mm</p>
	<p>804H-2 • Fender stay thickness $\phi 3.2$mm / $\phi 3.9$mm / $\phi 5$mm • Easy installation</p> <p>804H-2A: $\phi 3.2$mm 804H-2B: $\phi 3.9$mm 804H-2C: $\phi 5$mm</p>	
	<p>804H-3 • Fender stay thickness $\phi 3.2$mm / $\phi 3.9$mm / $\phi 5$mm / $\phi 6$mm stay eyelet • Stay eyelet diameter $\phi 6$mm</p> <p>804H-3A: $\phi 3.2$mm 804H-3B: $\phi 3.9$mm 804H-3C: $\phi 5$mm 804H-3D: $\phi 6$mm stay eyelet</p>	
	<p>804H-5 • Fender stay: $\phi 4.0$mm • Material: POM</p> <p>804H-5A: $\phi 3.2$mm 804H-5B: $\phi 3.9$mm 804H-5C: $\phi 5$mm</p>	
	<p>804M SLIDE SHIM • Slidable shim gives the possibility with 10mm length adjustment to fender stay.</p>	 <p>804M-1 SLIDE SHIM • Can with no limited length adjustment to fender stay • only fit $\phi 5$mm fender strut</p>

FV-115 Patented

Material: (POM+PA6) / 304 Stainless

POP-OFF SAFETY QR FASTENER



Fixed stay eyelet
 Strut snap on system



FENDER STAY SAFETY POP-OFF

STAY SAFETY	DESCRIPTION	FIT STAY	FUNCTION
 <p>FPOP</p>	<p>QR FASTENER (For $\phi 3.2 / \phi 4$ mm FENDER-STAY) Material: POM Slide along fender for position adjust. Allows 20mm travel adjustment.</p>	<p>POI POV</p>	
 <p>POP OFF</p>	<p>SAFETY QR FASTENER (For $\phi 3.2 / \phi 4$ mm FENDER-STAY) Material: POM Safety design to detach in accident and prevent jamming the wheel. (QR) quick release, easy installation and allows 20mm stay length adjustment.</p> <p>SAFETY QR FASTENER (For $\phi 3.2$ mm FENDER-STAY) Material: POM Safety design to detach in accident and prevent jamming the wheel. (QR) quick release, easy installation and allows 20mm stay length adjustment.</p>	<p>POI POV</p>	 <p>Auto-detach When Jammed</p>
 <p>POP OFF 3</p>	<p>SAFETY QR FASTENER (For $\phi 3.2 / \phi 4$ mm FENDER-STAY) Material: POM Safety design to detach in accident and prevent jamming the wheel. (QR) quick release, easy installation and allows 20mm stay length adjustment.</p>	<p>POI POV</p>	 <p>Auto-detach When Jammed</p>
 <p>POP OFF 5</p>	<p>SAFETY QR FASTENER (For $\phi 3.2 / \phi 4$ mm FENDER-STAY and SW-FE-119 / SW-FE-311-100 / EZ) Material: POM Safety design to detach in accident and prevent jamming the wheel. (QR) quick release, easy installation and allows 20mm stay length adjustment.</p>	<p>POI POV</p>	 <p>Auto-detac When Jammed</p>
 <p>FV-517 Patented (For $\phi 5$ mm FENDER-STAY) Adjustable Fender Stay Material: PA6 / Aluminum Length: 120mm. Applicable to MSA/MSB fender-stays to adjust the length.</p> <p>e.g. 29" Bike MSA Fender Stay Length : 394mm. MSA Fender Stay can be adjusted to a length of 394 to 514 mm.</p> <p>FV-517-1 FENDER STAY SAFETY POP-OFF Material: PA6 / Aluminum Length: 120mm. Applicable to MSA/MSB fender-stays to adjust the length.</p>	<p>UPPER-MOUNTED FENDER STAY</p>		

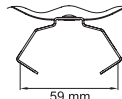
FENDER FIXTURES



 <p>SW-800A ~ SW-800I REMOVABLE PLASTIC HANGER</p> <ul style="list-style-type: none"> • Easy to install and good weathering resistant. • Material: POM • Colour: BK 	 <p>STAINLESS STEEL SELF-BEND HANGER</p> <ul style="list-style-type: none"> • Material: Stainless Steel • Fit for Resin Fender Width: Short: 35mm ~ 50mm Long: 50mm ~ 80mm 
 <p>SW-805B PRE-BENT CARRIER TYPE HANGER</p> <ul style="list-style-type: none"> • Connects between carrier & fender when fastener is not used. • Pre-bent to fit selected fender and cutout ready to fit reflector. • Material: Steel / Finishing: ED BK • Fit for Fender Width ≤ 59mm 	 <p>SW-805E SELF-BEND CARRIER TYPE HANGER</p> <ul style="list-style-type: none"> • Connects between carrier & fender when fastener is not used. • Pre-bent to fit selected fender and cutout ready to fit reflector. • Material: Steel / Finishing: ED BK • Fit for Resin Fender Width: 50mm ~ 70mm 
 <p>SCBM-1 STANDARD FENDER-CHAINSTAY BRIDGE MOUNT (For Fender Width within 55mm.)</p> <ul style="list-style-type: none"> • Bolt fits between fender and chainstay bridge. 	 <p>SCBM-2 STANDARD FENDER-CHAINSTAY BRIDGE MOUNT (For Fender Width above 60mm.)</p> <ul style="list-style-type: none"> • Bolt fits between fender and chainstay bridge.
 <p>SW-804B QUICK CLIP FENDER-CHAINSTAY BRIDGE MOUNT</p> <ul style="list-style-type: none"> • Material: Steel / Finishing: ED BK • For chain stay ≤ ø15mm • Clip-in between fender and chainstay bridge (no tool required) 	 <p>SW-804B-1 QUICK CLIP FENDER-SEAT TUBE STAY BRIDGE MOUNT</p> <ul style="list-style-type: none"> • Material: PA6 / Finishing: BLACK • Fit ø28.6 ~ ø31.8mm seat-tube.
 <p>FE-113R QUICK MOUNT (FOR SEAT TUBE BRIDGE)</p> <ul style="list-style-type: none"> • Easy installation. • Elastic rubber strap. 	 <p>SA1-01 QUICK CLIP FENDER-SEAT (FOR FRONT FORK HOLE)</p> <ul style="list-style-type: none"> • Finishing: BLACK SW-FE-113 / SW-FE-133 / SW-FE-135 
 <p>FE-113R1 QUICK MOUNT (FOR SEAT TUBE BRIDGE)</p> <ul style="list-style-type: none"> • Easy installation. • Elastic rubber strap. 	 <p>SW-802A HANGER-BRIDGE WASHER</p> <ul style="list-style-type: none"> • Material: PP R7mm recessed to fit bridge tube. 
 <p>SW-802B HANGER-FORK WASHER</p> <ul style="list-style-type: none"> • Material: PP R14.5mm recessed to fit fork sleeve tube. 	 <p>SW-804F BEVELED CUSHION</p> <ul style="list-style-type: none"> • Material: TPR • For clearance 2mm~ 5mm. • Fix between fender and carrier for noise reduction purpose.
 <p>SW-804F01 PAD</p> <ul style="list-style-type: none"> • Material: PP • Adapt with SW-804F ,for clearance ≥ 5mm. 	 <p>804F01 804F</p>

FENDER TAILS





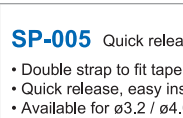

FIX & MATERIAL	FENDER TAIL	MODEL	FIT FENDER
RIVET FIX (T.P.R.)		SW-803C-35	SW-819
		SW-803C-40	SW-821
		SW-803C-45	SW-FE-111 SW-814
		SW-803C-50	SW-816
		SW-803C-60	SW-812 SW-822 SW-823
		SW-803C-70	SW-FE-311-70
		SW-803C-80	SW-825
		SW-803C-122	SW-FE-119
		SW-803 J	SW-821
		SW-803 K	SW-814 SW-FE-111
		SW-803 L	SW-816 SW-818
		SW-803 M	SW-813 SW-820 SW-823 SW-FE-311-55E1 SW-812 SW-FE-311-60E3 SW-817
CLIP FIX (T.P.R.+PP)		SW-803 N	SW-822 SW-FE-115
		SW-803 O	SW-819 SW-824
		SW-803 D	SW-814 SW-816 SW-FE-111
		SW-803 H	SW-819 SW-824 SW-821
		SW-803 P	SW-813
		SW-803 Q	SW-819 SW-821

FIX & MATERIAL	FENDER TAIL	MODEL	FIT FENDER
	SW-803P-70E SW-803P-80E	SW-FE-139-70E2	
		SW-FE-139-80E1	
RIVET FIX (T.P.R.)		SW-803N-70	SW-FE-311-70 SW-FE-311-65E3 SW-FE-311-70E3
		SW-803 Q	SW-814 SW-816 SW-818
CLIP FIX (T.P.R.+PP)		SW-803 U	SW-819
		SW-803 R	SW-FE-311-55E1 SW-820 SW-FE-311-60E3
		SW-803 V	SW-822 SW-FE-115
		SW-803 S	SW-812 SW-823
		SW-803 S-30 SW-803 S-38 SW-803 S-45	SW-FE-113 SW-FE-133 SW-FE-135
	SW-803V-65E	SW-FE-311-65E3	
	SW-803V-70E	SW-FE-311-70 SW-FE-311-70E3	

FENDER STAY / SEAT STAY HARDWARE

 <p>SP-005 Quick release stay bracket (double strap + plastic screw fix)</p> <ul style="list-style-type: none"> • Double strap to fit tapered suspension fork. • Quick release, easy installation and adjustment. • Available for ø3.2 / ø4.0 mm stay. 	 <p>SP-009 (Front Fork Clamp)</p> <p>SP-009-01: ø39mm SP-009-04: ø43mm SP-009-02: ø41mm SP-009-05: ø44mm SP-009-03: ø42mm SP-009-06: ø45mm</p> <ul style="list-style-type: none"> • Suitable for straight suspension fork.
 <p>SP-011 One-piece-made Quick release stay bracket</p> <ul style="list-style-type: none"> • Easy installation with elastic rubber strap. • Double strap to fit tapered / straight fork. 	 <p>SP-013 Quick release stay bracket.(plastic screw fix)</p> <ul style="list-style-type: none"> • Quick release, easy installation and adjustment. • SP-013-01: Available ø12.7~25.4mm • SP-013-02: Available ø19~65mm • Fender stay eyelet / FV-517 / FV-515

FENDER STAY / DROPOUT HARDWARE

 <p>TYPE 1 FIX-LENGTH STAY WITH 1/4" END</p> <ul style="list-style-type: none"> • Fixes on dropout or fork end eyelets. • Length customizable. • ø5 / ø6mm 	 <p>TYPE 2 FIX-LENGTH STAY WITH 5/16" END</p> <ul style="list-style-type: none"> • Fixes on front or rear hub axle. • Length customizable. • ø8mm
 <p>TYPE 3 FIX-LENGTH STAY WITH 3/8" END</p> <ul style="list-style-type: none"> • Fixes on front or rear hub axle. • Length customizable. • ø10mm 	 <p>TYPE 4 MICRO-ADJUSTABLE STAY WITH U-SHAPE 1/4" END</p> <ul style="list-style-type: none"> • Fixes on dropout or fork end eyelets with M5/M6 screw. • Length customizable. • ø5mm
 <p>TYPE 5 MICRO ADJUSTABLE</p> <ul style="list-style-type: none"> • Material: 304 Stainless Steel • Stay length adjustable by fix SW-804 clips to dropout or fork end eyelets. 	 <p>PATTERN STAMPING</p> <ul style="list-style-type: none"> • Prevent rotation <p>CUSTOM ANGLE BENDING</p>

FENDER COLOR CHART

- Fender color and foil application customizable.
- Fender length customizable.



RF-Z01
Solid Black



RF-D01
Dim Black



RF-F01
Flat Black



RF-C01
Coated Matt Black



RF-M01
Metallic Black



RF-T01
Black Transparent



RF-R01
Reflective Strap-Lateral edge



RF-R02
Reflective Strap-Centre



RF-L01
Black + 2 Clear Lines



RF-L02
White + 2 Black Lines



RF-A01
Clear Transparent
+ Matte Aluminium Foil



RF-A02
Clear Transparent
+ Shiny Aluminium Foil



RF-A03
Clear Transparent
/ Matte Aluminium Foil
+ 2 Clear Lines



RF-A04
Black Transparent
/ Matte Aluminium Foil
+ 4 Clear Lines



RF-A05
Matte Aluminium Foil
+ 2 Clear Lines
+ Centre Shiny Aluminium Foil



RF-L03
Colour-Side line



RF-E01
Centre Etching



RF-E02
Etching+ Matte Aluminium Foil

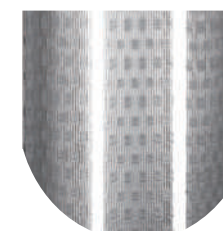

RF-E03
Etching+ 2 Clear Lines



RF-RC-01
Post-Consumer Recycled
Material ECO Friendly
Solid Black exclusive

CABLE STORAGE TECH

SW-801E
SINGLE Cable Tunnel
• Fit Cable within $\varnothing 3.5\text{mm}$
• cable length: 150cm
• Slide-in

SW-801E1
Patented
Cable Tunnel
(Fit Cable within $\varnothing 3\text{mm}$)

SW-801E2 **Patented**
Cable Tunnel
(Fit Cable within $\varnothing 3\text{mm}$ & $\varnothing 5\text{mm}$)

SW-801E3
Patented
Cable Tunnel
(Fit Cable within $\varnothing 5\text{mm}$)

SW-801E4
Patented
Cable Tunnel
(Fit Cable within $\varnothing 3.8\text{mm}$)

SW-809-01
Patented
Cable Tunnel Tool
• Fit Cable within $\varnothing 5\text{mm}$
• Single or double cables.

SW-808
Fit Cable within $\varnothing 25\text{mm}$

SW-807B
Patented
Cable Tunnel Tool
• Slide-able and easy Snap-in
• Fit Cable within $\varnothing 10\text{mm}$
• Stable
• Single or multiple cables.

SW-807B-1 SW-807B-3 **Patented**
Cable Tunnel Tool
• Slide-able and easy Snap-in
• Fit Cable within $\varnothing 10\text{mm}$
• Can be assembled on both side
• Only for SW-801E3

SW-804E
Washer
• Material: Stainless
• Finish: ED black
• For M5 screw

SW-801B
Cable Buttons
(Button distance: 105mm)
• Fit Cable within $\varnothing 2\text{mm}$

SW-801C
Cable Tunnel
• Fit Cable within $\varnothing 4.5\text{mm}$
• Fit $\varnothing 3.9\text{mm}$ fender stay

SW-NP-111
License Plate Holder
• Material: PA6+30%GF
• Tire fit: 26"-28"
• P.C & ALU.
full-cover applicable.

SW-FC-111F
• Compatible with LITEMOVE AE-200 Speed Pedelec
• For Fender width 45mm-80mm / 700C-29" bike

SW-FC-111R
• Compatible with LITEMOVE TS-FD
• For Fender width 45mm-80mm / 700C-29" bike

SW-FE-137

- Material: PC
- Designed for Road-bike.

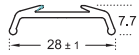

Sleek Look on Roadbike



Sleek Look on Roadbike



Smart Fixture for Roadbike



Slide-in Fender Stay

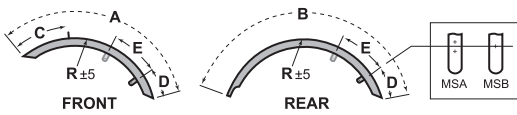

MODEL	SIZE	WIDTH	R	A	B	C	D	E	HANGER	TIRE SIZE
FE-137	650B 700C	28mm	370	640	1125				FE-13703	20C ~ 23C

FENDER-STAY

FE-13703 | MSI | MSV

STAY-DROPOUT

TYPE 1 ~ 5



SW-FE-113

- Material: PC
- Designed for Road-bike.

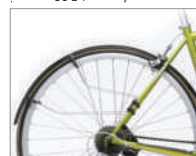
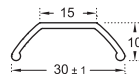

Sleek Look Roadbike



Sleek Look Roadbike



Quick-release Fender Stay (SP-011)



Smart Fixture for Roadbike



Safety-release(POP OFF3)



Quick-release(SA1-01+FE-113R)

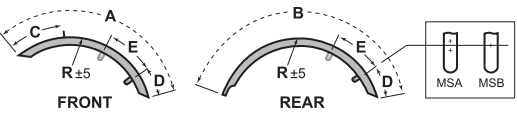

MODEL	SIZE	WIDTH	R	A	B	C	D	E	HANGER	TIRE SIZE
FE-113	650B 700C	30mm	370	640	1125	190			SW-800P-A	20C ~ 25C

FENDER TAIL

SW-803S-30

FENDER FIXTURES

SW-815 | L-Hanger

FENDER-STAY

POI | POV

STAY-DROPOUT

TYPE 1 ~ 5



L-HANGER CHART(Curved Design)

• Material: 304 Stainless Steel

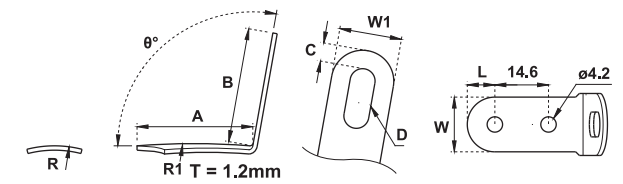

* Standard: **SW-8001** for Front Fender / **SW-8002** for Rear Fender.

HANGER	θ°	A	B	C	D	L	W	W1	R	R1
*8001	100°	31.5	31.4	5.1	6.8 x 21.5	7.5	15	17	12.9	156.8
*8002	100°	31.3	24.4	4.6	6.8 x 16	7.5	14	16	12.9	156.8
8003	104°	28.5	26	3.3	6.5 x 13	4.5	13	13	12.9	156.8
8004	100°	31.5	25.9	4	6.5 x 15	7.5	15	17	12.9	
8005	100°	31.5	53.8	5	7.5 x 22.5	7.5	15	17.5	30	
8005-2	100°	31.5	53.8	5	9.5 x 22.5	7.5	15	17.5	30	
8006	100°	31.5	38.8	5	7.5 x 22.5	7.5	15	17.5	12.9	156.8
8006-1	100°	31.5	38.8	5	6.8 x 20	7.5	15	17.5	12.9	156.8
8006-4	100°	31.5	38.8	5	5.2 x 22.5	7.5	15	17.5	12.9	156.8
8007	100°	31.3	30.6	5.1	6.8 x 16.5	7.2	12.7	17	12.9	156.8
8007-1	106°	31.3	30.6	5.1	6.8 x 16.5	7.2	12.7	17	12.9	156.8
8008	86°	31.5	31.4	5.1	6.8 x 21.5	7.5	15	17	12.9	156.8
8009	84°	31.5	25.9	4	6.5 x 15	7.5	15	17	12.9	156.8
8010	104°	31.5	31.4	5.1	6.8 x 21.5	7.5	15	17	12.9	156.8
8011	106°	31.5	31.4	5.1	6.8 x 21.5	7.5	15	17	12.9	156.8
8012	110°	31.5	31.4	5.1	6.8 x 21.5	7.5	15	17	12.9	156.8
8014	104°	28.5	31.4	3.3	6.5 x 16.5	4.5	13	13	13	
8015	106°	31	37.5	5	7.5 x 23	7.5	15	17.5	12.9	156.8
8017	92°	31.3	24.4	4.6	6.8 x 16	7.5	14	16	12.9	320
8018	92°	31.5	31.4	5.1	6.8 x 21.5	7.5	15	17	12.9	156.8
8019	84°	31.5	36	5	6.8 x 26	7.5	15	17.5	12.9	156.8
8019-1	100°	31.5	36	5	6.8 x 26	7.5	15	17.5	12.9	156.8
8022	90°	31.6	31.4	5	6.8 x 24.5	7.5	14.5	17	17	371.27 *only for FE-131
8023	90°	29.5	26	4.3	6.8 x 18	4.5	18	18		185 *only UPPER
8024	90°	29.5	19.3	4.3	6.8 x 11	4.5	18	18		185 *only UPPER

L-HANGER CHART(Flat Design)

• Material: 304 Stainless Steel

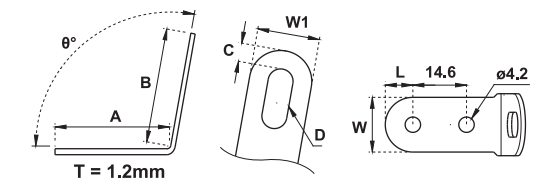

* Standard: **SW-815** for Front Fender / **SW-8002-1** for Rear Fender.

HANGER	θ°	A	B	C	D	L	W	W1	R	R1
8002-1	100°	31.3	24.4	4.6	6.8 x 16	7.5	14	16		
8005-1	120°	31.5	53.8	5	7.5 x 22.5	7.5	15	17.5		
8006-2	77°	31.5	38.8	5	7.5 x 22.5	7.5	15	17.5		
8006-3	85°	31.5	38.8	5	7.5 x 22.5	7.5	15	17.5		
8020	90°	31.4	27	5.1	6.5 x 17	7.5	15	17		156.8
815	100°	31.5	32	5.1	6.8 x 15.5	7.5	15	17		
815-1	100°	38.9	24	5.1	6.8 x 15.5	7.5	15	17		
8021	92°	31.5	24	4.6	6.8 x 16	7.5	14	16		

SW-821

- Material: PC
- Various color choices.

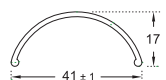

- FENDER TAIL**
SW-803J | SW-803I | SW-803H
SW-803C-40
- FENDER FIXTURES**
SW-800E | SW-804B | SW-801B
SW-801C | L-Hanger | SCBM-1
- FENDER-STAY**
MSA | MSB | MSI | MSV
POI | POV
- STAY-DROPOUT**
TYPE 1 ~ 5

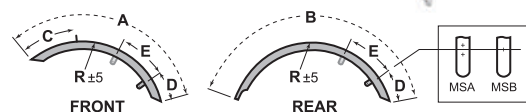

MODEL	SIZE	WIDTH	R	A	B	C	D	E	HANGER	TIRE SIZE
SW-821	20"	41mm	275	490	855	145	70	170	SW-800E	1" ~1.375" or 25C ~35C
	650B 700C		370	640	1125	190		240		

SW-814

- Material: PC
- Various color choices.



- FENDER TAIL**
SW-803C | SW-803D | SW-803K
SW-803Q | SW-803C-45
- FENDER FIXTURES**
SW-800A | SW-804B | SW-805E
SW-801B | SW-801C | L-Hanger
SW-800J | SCBM-1
- FENDER-STAY**
MSA | MSB | MSI | MSV
POI | POV
- STAY-DROPOUT**
TYPE 1 ~ 5

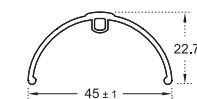
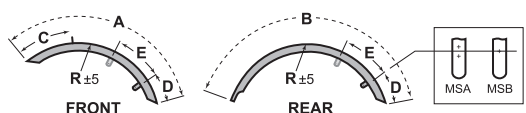

SW-814E
*Only for 650B 700C and 28" Holds up to 2 Cables

MODEL	SIZE	WIDTH	R	A	B	C	D	E	HANGER	TIRE SIZE
SW-814	20"	45mm	275	490	855	145	70	170	SW-800A SW-800J SW-800X	1.1" ~ 1.5" or 28C ~ 38C
	24"		325	575	1010	170		205		
	26"		350	620	1085	185		220		
	650B 700C		370	640	1125	190		240		
	27.5"		375							
	28"		380							

SW-819

- Material: PC
- Various color choices.

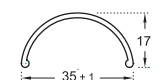

- FENDER TAIL**
SW-803H | SW-803I | SW-803O
SW-803U | SW-803C-35
- FENDER FIXTURES**
SW-800E | SW-804B | SW-801B
SW-801C | L-Hanger | SCBM-1
SW-800U
- FENDER-STAY**
MSA | MSB | MSI | MSV
POI | POV
- STAY-DROPOUT**
TYPE 1 ~ 5

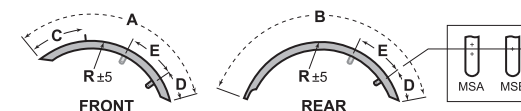

MODEL	SIZE	WIDTH	R	A	B	C	D	E	HANGER	TIRE SIZE
SW-819	20"	35mm	275	490	855	145	70	170	SW-800E SW-800U	1" ~1.125" or 20C ~ 28C
	650B 700C		370	640	1125	190		240		

SW-FE-133

- Material: PC
- Designed for Road-bike.

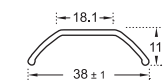

Safety-release(POP OFF3)



Quick-release(SA1-01+FE-113R)



- FENDER TAIL**
SW-803S-38
- FENDER FIXTURES**
SW-815 | L-Hanger
- FENDER-STAY**
MSI | MSV | POI | POV
- STAY-DROPOUT**
TYPE 1 ~ 5

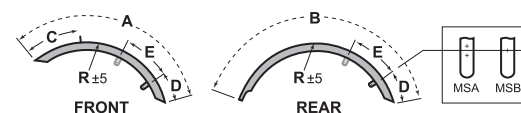

MODEL	SIZE	WIDTH	R	A	B	C	D	E	HANGER	TIRE SIZE
FE-133	650B 700C	38mm	370	640	1125	190	70	240	SW-800P-C	1" ~ 1.25" or 22C ~ 32C

SW-816

- Material: PC
- Various color choices.

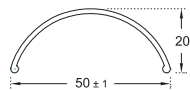

FENDER TAIL

SW-803F | SW-803D | SW-803L
SW-803Q | SW-803C-50

FENDER FIXTURES

SW-800D | SW-804B | SW-805E
SW-805B | SW-801B | SW-801C
SW-800K | L-Hanger | SCBM-1

FENDER-STAY

MSA | MSB | MSI | MSV
POI | POV

STAY-DROPOUT

TYPE 1 ~ 5

SW-FE-139 E1/E2/E3

- Material: PC
- Various color choices.

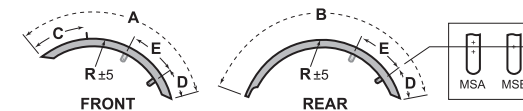
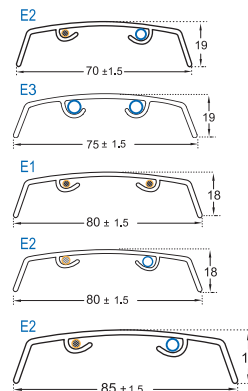

FENDER FIXTURES

SW-800Y1 | L-Hanger
SCBM-2

FENDER-STAY

MSA | MSB | MSI | MSV
FV Series

STAY-DROPOUT

TYPE 1 ~ 5

MODEL	SIZE	WIDTH	R	A	B	C	D	E	HANGER	TIRE SIZE
FE-139-80E1	28"	80	380	640	1125	190	70	240	SW-800Y1	2.5" ~ 2.7"
	29"		395	670	1175	195		255		
FE-139-80E2	29"	80	395	670	1175	195	70	255	SW-800Y1	2.5" ~ 2.7"
FE-139-70E2	650B 700C	70	370	640	1125	190	70	240	SW-800V1	2.1" ~ 2.5"
	27.5"		375					240		
FE-139-75E3	20"	70	275	490	855	145	70	170	N/A	2.35" ~ 2.7"
	26"		350	620	1085	185		220		
FE-139-85E2	650B 700C	85	370	640	1125	190	70	240	N/A	2.7" ~ 3.3"
	27.5"		375					240		

SW-FE-135

- Material: PC
- Designed for Road-bike.

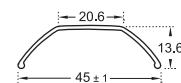

Safety-release(POP OFF3)



Quick-release(SA1-01+FE-113R)

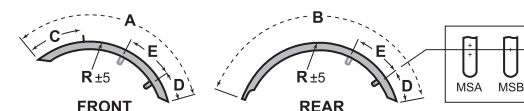

FENDER TAIL

SW-803S-45

FENDER FIXTURES

SW-815 | L-Hanger

FENDER-STAY

MSI | MSV | POI | POV
MSA | MSB

STAY-DROPOUT

TYPE 1 ~ 5

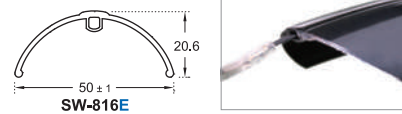
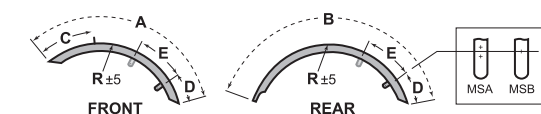

SW-816E
*Only for 22" 24" 26" 650B and 700C.

Holds up to 2 Cables

MODEL	SIZE	WIDTH	R	A	B	C	D	E	HANGER	TIRE SIZE
SW-816	12"	50mm	175	305	510	110	70	100	SW-800D SW-800K	1.35" ~ 1.625" or 35C ~ 40C
	14"		200	350	590	130		115		
	16"		225	410	620	145		135		
	18"		250	435	740	150		150		
	20"		275	490	855	170		170		
	22"		310	525	890	155		195		
	24"		325	575	1010	170		205		
	26"		350	620	1085	185		220		
	650B 700C		370	640	1125	190		240		
	27.5"		375							
	28"		380							

MODEL	SIZE	WIDTH	R	A	B	C	D	E	HANGER	TIRE SIZE
FE-135	650B 700C	45mm	370	640	1125	190	70	240	SW-800E	1.1" ~ 1.5" or 28C ~ 38C

SW-813

- Material: PC
- Various color choices.

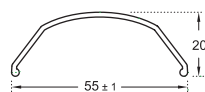

FENDER TAIL

SW-803F | SW-803M | SW-803P
SW-803S

FENDER FIXTURES

SW-800D | SW-804B | SW-805E
SW-801B | SW-801C | L-Hanger
SCBM-1

FENDER-STAY

MSA | MSB | MSI | MSV
POI | POV

STAY-DROPOUT

TYPE 1 ~ 5

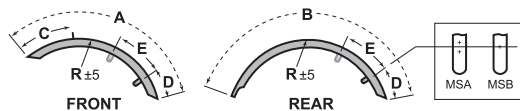

MODEL	SIZE	WIDTH	R	A	B	C	D	E	HANGER	TIRE SIZE
SW-813	16"	55mm	225	410	620	145	70	135	SW-800D	1.5"~1.9" or 38C ~ 45C
	18"		250	435	740			150		
	20"		275	490	855			170		

SW-818

- Material: PC
- Various color choices.

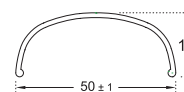

FENDER TAIL

SW-803F | SW-803L | SW-803Q

FENDER FIXTURES

SW-800D | SW-804B | SW-805E
SW-801B | SW-801C | L-Hanger
SCBM-1

FENDER-STAY

MSA | MSB | MSI | MSV
POI | POV

STAY-DROPOUT

TYPE 1 ~ 5

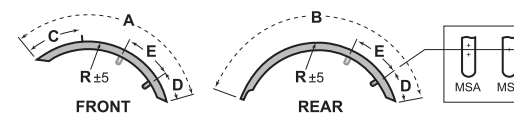

MODEL	SIZE	WIDTH	R	A	B	C	D	E	HANGER	TIRE SIZE
SW-818	26"	50mm	350	620	1085	185	70	220	SW-800D	1.35" ~1.625" or 35C ~ 40C
	650B 700C		375	640	1125	190		240		

SW-FE-117

- Material: PC
- Various color choices.

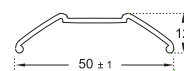

FENDER FIXTURES

SW-800S-B | L-Hanger
SCBM-1

FENDER-STAY

MSA | MSB | MSI | MSV
POI | POV

STAY-DROPOUT

TYPE 1 ~ 5

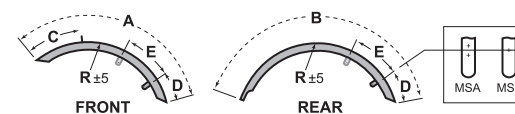

MODEL	SIZE	WIDTH	R	A	B	C	D	E	HANGER	TIRE SIZE
SW-FE-117	650B 700C	50mm	370	640	1125	190	70	240	SW-800S-B	1.35" ~1.625" or 35C ~ 40C

SW-812

- Material: PC
- Various color choices.

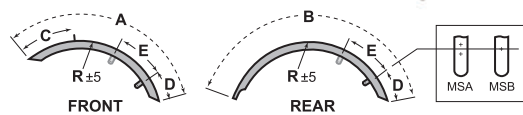
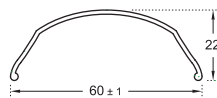

MODEL	SIZE	WIDTH	R	A	B	C	D	E	HANGER	TIRE SIZE
SW-812	20"	60mm	275	490	855	145	70	170	SW-800B	1.75" ~ 2.125" or 45C
	24"		325	575	1010	170		205		
	26"		350	620	1085	185		220		

FENDER TAIL

SW-803E | SW-803N | SW-803S
SW-803C-60

FENDER FIXTURES

SW-800B | SW-804B | SW-805E
SW-805B | SW-801B | SW-801C
L-Hanger | SCBM-2

FENDER-STAY

MSA | MSB | MSI | MSV
POI | POV

STAY-DROPOUT

TYPE 1 ~ 5

SW-817

- Material: PC
- Various color choices.

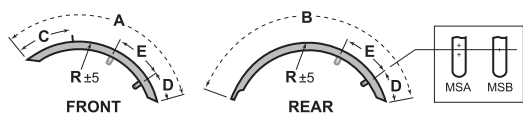
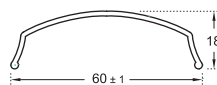

MODEL	SIZE	WIDTH	R	A	B	C	D	E	HANGER	TIRE SIZE
SW-817	24"	60mm	325	575	1010	170	70	205	SW-800C	1.75" ~ 2.125" or 45C
	26"		350	620	1085	185		220		
	27.5"		375	640	1125	190		240		
	29"		395	670	1175	195		255		

FENDER TAIL

SW-803G | SW-803N
SW-803C-60

FENDER FIXTURES

SW-800C | SW-804B | SW-805E
SW-801B | SW-801C | L-Hanger
SCBM-1 | SCBM-2

FENDER-STAY

MSA | MSB | MSI | MSV
POI | POV

STAY-DROPOUT

TYPE 1 ~ 5

SW-820

- Material: PC
- Various color choices.

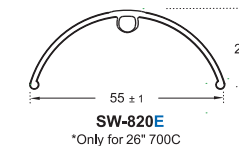
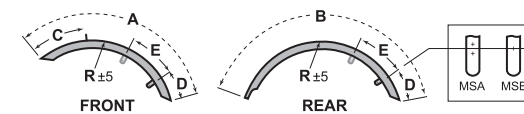
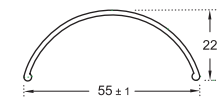

MODEL	SIZE	WIDTH	R	A	B	C	D	E	HANGER	TIRE SIZE
SW-820	20"	55mm	275	490	855	145	70	170	SW-800I	1.5"~1.9" or 38C ~ 45C
	24"		325	575	1010	170		205		
	26"		350	620	1085	185		220		
	650B 700C		370	640	1125	190		240		
SW-820E	26"	700C	350	620	1085	185	70	220	SW-800H	1.5"~1.9" or 38C ~ 45C
	700C		370	640	1125	190		240		
	29"		395	670	1175	195		255		

FENDER TAIL

SW-803G | SW-803M | SW-803R

FENDER FIXTURES

SW-800I | SW-804B | SW-805E
SW-801B | SW-801C | L-Hanger
SCBM-1

FENDER-STAY

MSA | MSB | MSI | MSV
POI | POV

STAY-DROPOUT

TYPE 1 ~ 4

SW-823

- Material: PC
- Various color choices.

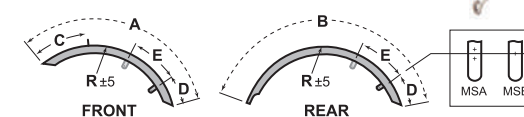
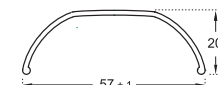

MODEL	SIZE	WIDTH	R	A	B	C	D	E	HANGER	TIRE SIZE
SW-823	650B 700C	57mm	370	640	1125	190	70	240	SW-800I	1.6" ~ 2" or 40C-45C

FENDER TAIL

SW-803M | SW-803S
SW-803C-60

FENDER FIXTURES

SW-805E | SW-805B | SW-804B
SW-801B | SW-801C | L-Hanger
SCBM-2

FENDER-STAY

MSA | MSB | MSI | MSV
POI | POV

STAY-DROPOUT

TYPE 1 ~ 5

SW-825

- Material: PC
- Designed for Cruiser Bike.
- Various color choices.

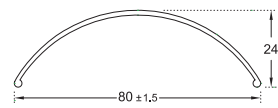

FENDER FIXTURES

L-Hanger | SCBM-2
SW-803C-80

FENDER-STAY

MSA | MSB | MSI | MSV
POI | POV | POP OFF 5

STAY-DROPOUT

TYPE 1 ~ 5

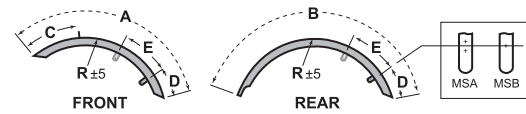

MODEL	SIZE	WIDTH	R	A	B	C	D	E	HANGER	TIRE SIZE
SW-825	20"	80mm	275	490	855	145	70	170	SW-800Y	2.5" ~ 2.7"
	24"		325	575	1010	170		205		
	26"		350	620	1085	185		220		
	27.5"		375	640	1125	190		240		
	29"		395	670	1175	195		255		

SW-FE-119

- Material: PC
- Designed for Snow-bike / Fat bike.
- Optional Safety QR fastener
- Only with POP OFF5

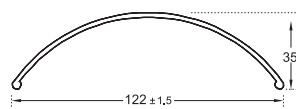

FENDER-STAY

MSA | MSB | MSI | MSV
POI | POV | POP OFF 5

STAY-DROPOUT

TYPE 1 ~ 5

FENDER TAIL

SW-803C-122

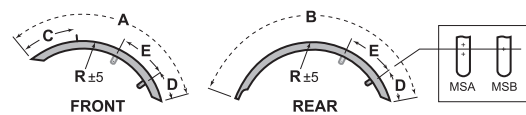

MODEL	SIZE	WIDTH	R	A	B	C	D	E	HANGER	TIRE SIZE
FE-119	20"	122mm	310	525	890	155	70	170	SW-800Z	4.0" ~ 4.5"
	26"		395	670	1175	195		220		

SW-822

- Material: PC
- Various color choices.

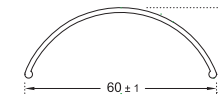

FENDER TAIL

SW-803G | SW-803V | SW-803N
SW-803C-60

FENDER FIXTURES

SW-800H | SW-805E | SW804B
SW-801B | SW-801C | L-Hanger
SCBM-2

FENDER-STAY

MSA | MSB | MSI | MSV
POI | POV

STAY-DROPOUT

TYPE 1 ~ 5

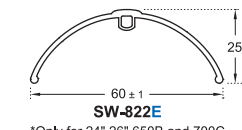
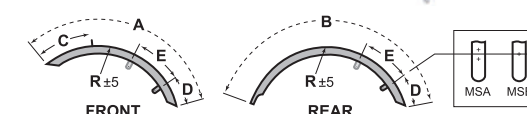

*Only for 24" 26" 650B and 700C



Holds up to 2 Cables

MODEL	SIZE	WIDTH	R	A	B	C	D	E	HANGER	TIRE SIZE	
SW-822	18"	60mm	250	435	740	145	70	150	SW-800H	1.75" ~ 2.125" or 45C	
	20"		275	490	855			170			
	24"		325	575	1010			205			
	26"		350	620	1085			185			220
	650B 700C		370	640	1125			190			240
	29"		395	670	1175			195			255

SW-FE-115

- Material: PC
- Various color choices.

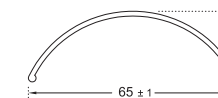

FENDER TAIL

SW-803N | SW-803V
SW-803C-60

FENDER FIXTURES

SW-800V | L-Hanger
SCBM-2

FENDER-STAY

MSA | MSB | MSI | MSV
POI | POV

STAY-DROPOUT

TYPE 1 ~ 5

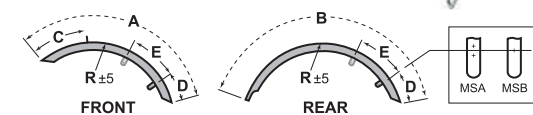

MODEL	SIZE	WIDTH	R	A	B	C	D	E	HANGER	TIRE SIZE	
FE-115	12"	65mm	175	305	510	110	70	100	SW-800V	1.9" ~ 2.2"	
	16"		225	410	620			135			
	20"		275	490	855			170			
	26"		350	620	1085			185			220
	27.5"		375	640	1125			190			240
	29"		395	670	1175			195			255

SW-FE-311 E1/E2/E3

- Material: PC
- Various color choices.

●ø3mm ○ø5mm

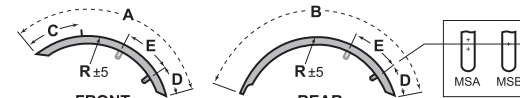
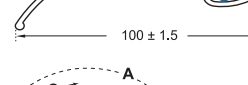
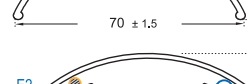
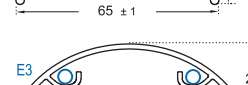
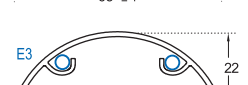
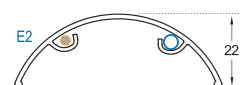
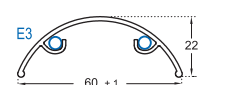
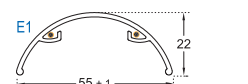
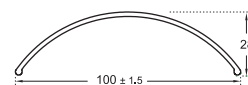
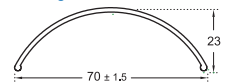

SW-FE-311

FENDER FIXTURES

SW-8001 | SW-800C | L-Hanger

FENDER-STAY

MSA | MSB | MSI | MSV
POI | POV

STAY-DROPOUT

TYPE 1-5

SW-FE-311 E1/E2/E3

FENDER FIXTURES

All Series

FENDER-STAY

MSA | MSB | MSI | MSV
POI | POV | FV Series

STAY-DROPOUT

TYPE 1-5



Cable Tunnel
(Fit Cable within ø3mm)
(cable length:150cm)

MODEL	SIZE	WIDTH	R	A	B	C	D	E	HANGER	FENDER TAIL	TIRE SIZE	
FE-311-70	14"	70	200	350	590	130	70	115	SW-800V2	SW-503H1 SW-803N SW-803V	2.1"~2.5"	
	18"		250	435	740	145		150				
	24"		325	575	1010	170		205				
	650B 700C		370	640	1125	190		240				
27.5"	375											
26"	100	395	525	890	155	195		N/A				3.2"~3.7"
24"		375	575	1010	170	205						
20"		325	620	1085	185	220						
26"		350	620	1085	185	220						
FE-311-55E1	650B 700C	55	370	640	1125	190		240	SW-800I1			1.5"~1.9" or 38C ~ 45C
27.5"	375											
FE-311-60E3	650B 700C	60	370	640	1125	190		240	SW-800I			1.75" ~ 2.125" or 45C
27.5"	375											
FE-311-65E2	16"	65	225	410	620	154	135	SW-800H		1.9" ~ 2.2"		
	20"		275	490	855	145	170					
	16"		225	410	620	154	135					
	20"		275	490	855	145	170					
FE-311-65E3	24"	65	325	575	1010	170	205					
	26"		350	620	1085	185	220					
	650B 700C		370	640	1125	190	240					
	27.5"		375									
29"	395	670	1175	195	255							
FE-311-70E3	14"	70	200	350	590	130	115	SW-800V2		2.1"~2.5"		
	18"		250	435	740	145	150					
	24"		325	575	1010	170	205					
	650B 700C		370	640	1125	190	240					
27.5"	375											
FE-311-100E2	20"	100	325	525	890	155	195	N/A		3.2"~3.7"		
	24"		575	1010	170	205						
	650B 700C		620	1085	185	220						
	27.5"		395	640	1125	190	240					

ALUMINUM FENDER PROFILE

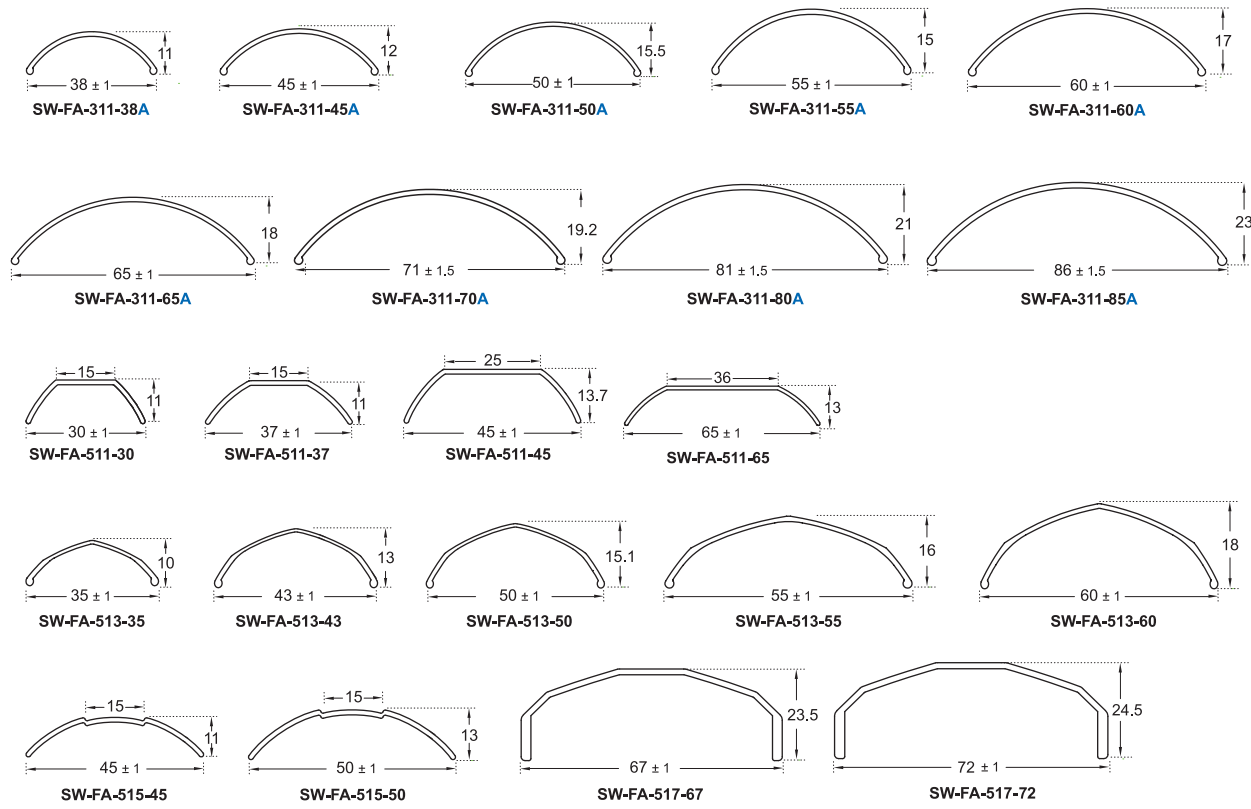

ALUMINUM FENDER CABLE STORAGE TECH PROFILE

- ∅ 3mm
- ∅ 5mm

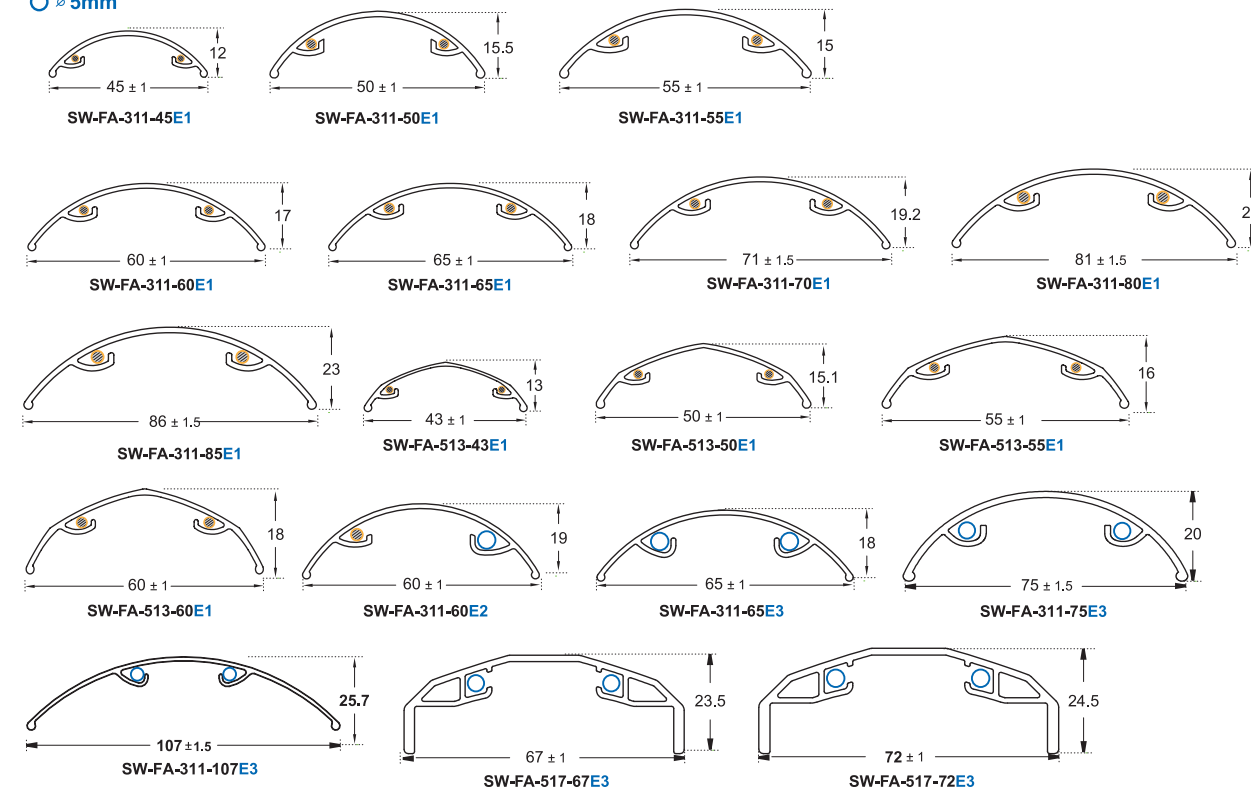

Aluminum Full-cover Fender

By taking the advantage of its characteristics, the Aluminum fenders not only are light-weight but also easy to shape by various production technics such as rolling and extrusion. Furthermore, the Aluminum fenders are able to be applied with different kind of surface treatments and create fine textures to fit on high-end bicycles.



FENDER CABLE STORAGE

MODEL	12"	14"	16"	18"	20"	22"	24"	26"	650B	700C	28"	29"
	R175	R200	R225	R250	R275	R310	R325	R350	R370	R370	R380	R395
FA-311-45E1					•	•	•	•	•	•	•	•
FA-311-50E1					•	•	•	•	•	•	•	•
FA-311-55E1					•	•	•	•	•	•	•	•
FA-311-60E1							•	•	•	•	•	•
FA-311-65E1							•	•	•	•	•	•
FA-311-70E1							•	•	•	•	•	•
FA-311-80E1							•	•	•	•	•	•
FA-311-85E1					•	•	•	•	•	•	•	•
FA-311-60E2							•	•	•	•	•	•
FA-311-65E3							•	•	•	•	•	•
FA-311-75E3					•	•	•	•	•	•	•	•
FA-311-107E3							•	•	•	•	•	•
FA-513-43E1					•	•	•	•	•	•	•	•
FA-513-50E1					•	•	•	•	•	•	•	•
FA-513-55E1					•	•	•	•	•	•	•	•
FA-513-60E1					•	•	•	•	•	•	•	•
FA-517-67E3					•	•	•	•	•	•	•	•
FA-517-72E3					•	•	•	•	•	•	•	•

FENDER STAY MOUNTING (FIXED)

ø3.2mm ø4.0mm

SELECTIVE STAY THICKNESS
All fender stay are available in ø3.2mm and ø4.0mm thickness to meet different needs.
Material: • 204 / 304 Stainless Steel: ø3.2 and ø4.0mm
• Steel (ED Black): ø4.0mm

SELECTIVE STAY EYELET DIAMETER

ø5mm^{+0.3}_{-0.1} ø6mm^{+0.3}_{-0.1} ø8mm^{+0.3}₋₀ ø10mm^{+0.3}_{-0.1}

MSA
UPPER-MOUNTED FENDER STAY
Fender stay mounted to the exterior of fenders with choice of stainless/chromed steel upper bracket.

MSB
UNDER-MOUNTED FENDER STAY
Fender stay mounted to the interior of fenders with bolt and screw only.

MSI
SINGLE-STAY + MOUNTED BRACKET
Single fender stay mounted to both sides of fenders with stainless steel under bracket.

MSV
V-STAY + MOUNTED BRACKET
V-style fender stay mounted to both sides of fenders with stainless steel under bracket.
*Recommendable for FRONT & REAR fenders. *stand ø40°

SW-FV-511 Patented
Flat Aluminum Fender Stay Fastener (For ø3.2 mm FENDER-STAY)

SW-FV-513 Patented
Curved Aluminum Fender Stay Fastener (For ø3.2 mm FENDER-STAY)









TIRE-WIDTH CHART

20C												
22C												
23C												
25C												
1"												
26C												
1.1"												
28C												
1.125"												
1.25"												
32C												
1.35"												
1.375"												
35C												
1.45"												
38C												
1.5"												
40C												
1.6"												
1.625"												
1.75"												
45C												
1.9"												
1.95"												
2"												
2.10"												
2.125"												
2.2"												
2.35"												
2.4"												
2.5"												
2.6"												
2.7"												
2.8"												
2.9"												
3"												
3.1"												
3.2"												
3.3"												
3.7"												
3.8"												
4.0"												



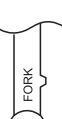
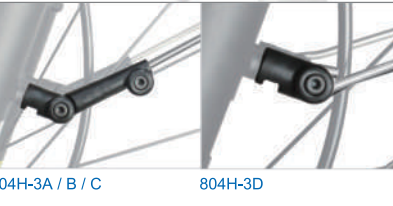

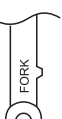



TIRE-FIT CHART

MODEL	12"	14"	16"	18"	20"	22"	24"	26"	650B	700C	28"	29"
	R175	R200	R225	R250	R275	R310	R325	R350	R370	R370	R380	R395
FA-311-38A					•	•	•	•	•	•	•	•
FA-311-45A					•	•	•	•	•	•	•	•
FA-311-50A					•	•	•	•	•	•	•	•
FA-311-55A					•	•	•	•	•	•	•	•
FA-311-60A							•	•	•	•	•	•
FA-311-65A							•	•	•	•	•	•
FA-311-70A							•	•	•	•	•	•
FA-311-80A							•	•	•	•	•	•
FA-311-85A							•	•	•	•	•	•
FA-511-30					•	•	•	•	•	•	•	•
FA-511-37					•	•	•	•	•	•	•	•
FA-511-45					•	•	•	•	•	•	•	•
FA-511-65					•	•	•	•	•	•	•	•
FA-513-35					•	•	•	•	•	•	•	•
FA-513-43					•	•	•	•	•	•	•	•
FA-513-50					•	•	•	•	•	•	•	•
FA-513-55					•	•	•	•	•	•	•	•
FA-513-60					•	•	•	•	•	•	•	•
FA-515-45					•	•	•	•	•	•	•	•
FA-515-50					•	•	•	•	•	•	•	•
FA-517-67					•	•	•	•	•	•	•	•
FA-517-72					•	•	•	•	•	•	•	•





	<p>804H-2</p> <ul style="list-style-type: none"> Fender stay thickness $\phi 3.2\text{mm}$ / $\phi 3.9\text{mm}$ / $\phi 5\text{mm}$ Easy installation <p>804H-2A: $\phi 3.2\text{mm}$ 804H-2B: $\phi 3.9\text{mm}$ 804H-2C: $\phi 5\text{mm}$</p>		
	<p>804H-3</p> <ul style="list-style-type: none"> Fender stay thickness $\phi 3.2\text{mm}$ / $\phi 3.9\text{mm}$ / $\phi 5\text{mm}$ / $\phi 6\text{mm}$ stay eyelet Stay eyelet diameter $\phi 6\text{mm}$ <p>804H-3A: $\phi 3.2\text{mm}$ 804H-3B: $\phi 3.9\text{mm}$ 804H-3C: $\phi 5\text{mm}$ 804H-3D: $\phi 6\text{mm}$ stay eyelet</p>		 <p>804H-3A / B / C 804H-3D</p>
	<p>804H-4</p> <ul style="list-style-type: none"> Fender stay: $\phi 9.0\text{mm}$ Material: Aluminum Finishing: Anodized shining black Coating black (gloss) Custom angle bending 		





FENDER STAY / DROPOUT HARDWARE

 <p>TYPE 1 FIX-LENGTH STAY WITH 1/4" END</p> <ul style="list-style-type: none"> Fixes on dropout or fork end eyelets. Length customizable. $\phi 5$ / $\phi 6\text{mm}$ 	 <p>TYPE 2 FIX-LENGTH STAY WITH 5/16" END</p> <ul style="list-style-type: none"> Fixes on front or rear hub axle. Length customizable. $\phi 8\text{mm}$
 <p>TYPE 3 FIX-LENGTH STAY WITH 3/8" END</p> <ul style="list-style-type: none"> Fixes on front or rear hub axle. Length customizable. $\phi 10\text{mm}$ 	 <p>TYPE 4 MICRO-ADJUSTABLE STAY WITH U-SHAPE 1/4" END</p> <ul style="list-style-type: none"> Fixes on dropout or fork end eyelets with M5/M6 screw. Length customizable. $\phi 5\text{mm}$
 <p>TYPE 5 MICRO ADJUSTABLE</p> <ul style="list-style-type: none"> Material: 304 Stainless Steel Stay length adjustable by fix SW-804 clips to dropout or fork end eyelets. 	 <p>804M SLIDE SHIM</p> <ul style="list-style-type: none"> Slidable shim gives the possibility with 10mm length adjustment to fender stay.  <p>804M-1 SLIDE SHIM</p> <ul style="list-style-type: none"> Can with no limited length adjustment to fender stay only fit $\phi 5\text{mm}$ fender strut
 <p>PATTERN STAMPING</p> <ul style="list-style-type: none"> Prevent rotation 	 <p>CUSTOM ANGLE BENDING</p>



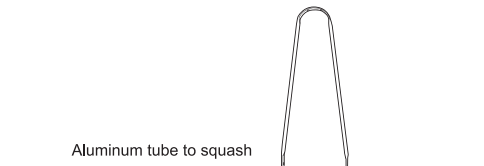
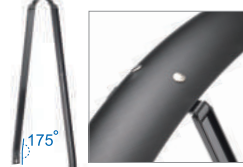

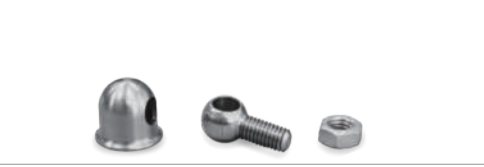



FENDER STAY SAFETY POP-OFF

STAY SAFETY	DESCRIPTION	TYPE / FEATURE	FUNCTION
	<p>FV-515 Patented (For $\phi 3.2$ / $\phi 4$ mm FENDER-STAY) FENDER STAY SAFETY POP-OFF Material: PA6 Applicable to MSA / MSB / MSI / MSV fender-stays to pop-off when jammed.</p>	<p>MSA MSB MSI MSV</p>	

FENDER STAY MOUNTING (FIXED)

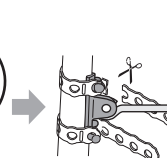
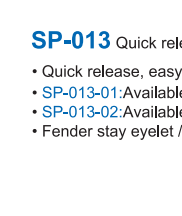
	<p>FV-111 Material: Aluminum</p> <p>UPPER-MOUNTED FENDER STAY</p>	 <p>Aluminum tube to squash</p>
	<p>FV-113A/B Patented Material: Aluminum / 304 Stainless</p> <p>UNDER-MOUNTED FENDER STAY</p>	 <p>FV-113A: Adjustable stay eyelet ;Strut snap on system. FV-113B: Fixed stay eyelet ;Strut snap on system.</p>
	<p>804N-02 UPPER-MOUNTED FENDER STAY</p> <p>Material: 303 Stainless</p>	
	<p>804E-1 UNDER-MOUNTED FENDER STAY Material: Zinc $\phi 4\text{mm}$ / $\phi 5\text{mm}$</p>	

FENDER STAY / SEAT STAY HARDWARE

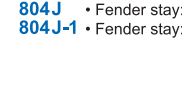
	<p>SP-005 Quick release stay bracket (double strap + plastic screw fix + clip fix)</p> <ul style="list-style-type: none"> Double strap to fit tapered suspension fork. Quick release, easy installation and adjustment. Available for $\phi 3.2$ / $\phi 4.0$ mm stay. 	
	<p>SP-009 (Front Fork Clamp)</p> <p>SP-009-01: $\phi 39\text{mm}$ SP-009-04: $\phi 43\text{mm}$ SP-009-02: $\phi 41\text{mm}$ SP-009-05: $\phi 44\text{mm}$ SP-009-03: $\phi 42\text{mm}$ SP-009-06: $\phi 45\text{mm}$</p> <ul style="list-style-type: none"> Suitable for straight suspension fork. 	
	<p>SP-011 One-piece-made Quick release stay bracket</p> <ul style="list-style-type: none"> Easy installation with elastic rubber strap. Double strap to fit tapered / straight fork. 	
	<p>SP-013 Quick release stay bracket.(plastic screw fix)</p> <ul style="list-style-type: none"> Quick release, easy installation and adjustment. SP-013-01: Available $\phi 12.7\sim 25.4\text{mm}$ SP-013-02: Available $\phi 19\sim 65\text{mm}$ Fender stay eyelet / FV-517 / FV-515 	
	<p>804H</p> <ul style="list-style-type: none"> Fender stay: $\phi 3.9\text{mm}$ Material: Steel Finishing: ED BK 	 <p>804H-1</p> <ul style="list-style-type: none"> Fender stay: $\phi 5.0\text{mm}$ Material: Steel Finishing: UCP
	<p>804H-5</p> <ul style="list-style-type: none"> Fender stay: $\phi 4.0\text{mm}$ Material: POM <p>804H-5A: $\phi 3.2\text{mm}$ 804H-5B: $\phi 3.9\text{mm}$ 804H-5C: $\phi 5\text{mm}$</p>	 <p>804J</p> <ul style="list-style-type: none"> Fender stay: $\phi 4.0\text{mm}$ <p>804J-1 • Fender stay: $\phi 3.2\text{mm}$</p> <p>804J-2 • Fender stay: $\phi 5\text{mm}$</p> <p>Prevent Rotation $\phi 5\text{mm}$ screw hole $\phi 6\text{mm}$ screw hole</p>

FENDER TAILS (FOR ALUMINUM FENDER)

FIX & MATERIAL	FRONT TAIL	REAR TAIL	MODEL	FIT FENDER
CLIP FIX (PC)			SW-503B5	FA-511-37
			SW-503B6	
			SW-503C3	FA-513-50
			SW-503C4	
			SW-503E3	FA-311-45
			SW-503E4	
			SW-503E1	FA-311-38
			SW-503E2	
			SW-503B3	FA-511-45
			SW-503B4	
		SW-503D3	FA-515-50	
		SW-503D4		
		SW-503A1	FA-111-55	
		SW-503A2		
		SW-503B1	FA-511-30	
		SW-503B2		
		SW-503D1	FA-515-45	
		SW-503D2		
		SW-503C1	FA-513-43	
		SW-503C2		
CLIP FIX (PP)			SW-503F1	FA-311-45E1
			SW-503G1	FA-311-50E1
			SW-503H1	FA-311-55E1
			SW-503I1	FA-311-60E1
			SW-503J1	FA-311-65E1
			SW-503K1	FA-513-50E1
			SW-503L1	FA-513-55E1
			SW-503M1	FA-513-60E1
			SW-503N1	FA-513-43E1
			SW-803 Q	FA-311-55 FA-311-55E1 FA-311-60E1
			SW-503O	FA-111-55
			SW-803V-70	FA-311-70A FA-311-70E1
		SW-803V-75	FA-311-75E3	
		SW-FA-517-67 SW-FA-517-67E3 SW-FA-517-72 SW-FA-517-72E3	SW-FA-517-67 SW-FA-517-67E3 SW-FA-517-72 SW-FA-517-72 E3	
RIVET FIX (TPR)			SW-803N-38	FA-311-38A
			SW-803N-45	FA-311-45A
			SW-803N-55	FA-311-55A
			SW-803N-70	FA-311-70A FA-311-70E1

COLOR: BLACK / BLACK TRANSPARENT

STAY SAFETY	DESCRIPTION	TYPE / FEATURE	FUNCTION
	<p>FV-517 Patented (For ø5 mm FENDER-STAY) Adjustable Fender Stay Material: PA6 / Aluminum Length: 120mm. Applicable to MSA/MSB fender-stays to adjust the length.</p> <p>e.g. 29" Bike MSA Fender Stay Length : 394mm. MSA Fender Stay can be adjusted to a length of 394 to 514 mm.</p>	UPPER-MOUNTED FENDER STAY	
	<p>FV-517-1 FENDER STAY SAFETY POP-OFF Material: PA6 / Aluminum Length: 120mm. Applicable to MSA/MSB fender-stays to adjust the length.</p>		
	<p>FV-115 Patented Material: (POM+PA6) / 304 Stainless POP OFF SAFETY OR FASTENER Fixed stay eyelet Strut snap on system</p>	UNDER-MOUNTED FENDER STAY	



FENDER FIXTURES



	<p>SW-800A ~ SW-800I REMOVABLE PLASTIC HANGER • Easy to install and good weathering resistant. • Material: POM • Colour: BK</p>		<p>STAINLESS STEEL SELF-BEND HANGER • Material: Stainless Steel • Fit for Resin Fender Width: Short: 35mm ~ 50mm Long: 50mm ~ 80mm</p>
	<p>SW-805B PRE-BENT CARRIER TYPE HANGER • Connects between carrier & fender when fastener is not used. • Pre-bent to fit selected fender and cutout ready to fit reflector. • Material: Steel / Finishing: ED BK • Fit for Fender Width ≤ 59mm</p>		<p>SW-805E SELF-BEND CARRIER TYPE HANGER • Connects between carrier & fender when fastener is not used. • Pre-bent to fit selected fender and cutout ready to fit reflector. • Material: Steel / Finishing: ED BK • Fit for Resin Fender Width: 50mm ~ 70mm</p>
	<p>SCBM-1 STANDARD FENDER-CHAINSTAY BRIDGE MOUNT (For Fender Width within 55mm.) • Bolt fits between fender and chainstay bridge.</p>		<p>SCBM-2 STANDARD FENDER-CHAINSTAY BRIDGE MOUNT (For Fender Width above 60mm.) • Bolt fits between fender and chainstay bridge.</p>
	<p>SW-804B QUICK CLIP FENDER-CHAINSTAY BRIDGE MOUNT • Material: Steel / Finishing: ED BK • For chain stay ≤ ø15mm • Clip-in between fender and chainstay bridge (no tool required)</p>		<p>SW-804B-1 QUICK CLIP FENDER-SEAT TUBE STAY BRIDGE MOUNT • Material: PA6 / Finishing: BLACK • Fit ø28.6 ~ ø31.8mm seat-tube.</p>
	<p>FE-113R QUICK MOUNT (FOR SEAT TUBE BRIDGE)</p>		<p>SW-802B HANGER-FORK WASHER • Material: PP</p> <p>R14.5mm recessed to fit fork sleeve tube.</p>
	<p>SW-802A HANGER-BRIDGE WASHER • Material: PP</p> <p>R7mm recessed to fit bridge tube.</p>		
	<p>SW-804F BEVELED CUSHION • Material: TPR • For clearance 2mm~ 5mm. • Fix between fender and carrier for noise reduction purpose.</p>		<p>SW-804F01 PAD • Material: PP • Adapt with SW-804F ,for clearance ≥ 5mm.</p>

CABLE STORAGE TECH



<p>SW-801C Cable Tunnel</p> <ul style="list-style-type: none"> Fit Cable within $\varnothing 4.5\text{mm}$ Fit $\varnothing 3.9\text{mm}$ fender stay 	<p>SW-801E1 Patented Cable Tunnel (Fit Cable within $\varnothing 3\text{mm}$)</p> 	<p>SW-801E2 Patented Cable Tunnel (Fit Cable within $\varnothing 3\text{mm}$ & $\varnothing 5\text{mm}$)</p> 
--	--	---

<p>SW-801E3 Patented Cable Tunnel (Fit Cable within $\varnothing 5\text{mm}$)</p> 	<p>SW-807B Patented Cable Tunnel Tool</p> <ul style="list-style-type: none"> Slide-able and easy Snap-in Fit Cable within $\varnothing 10\text{mm}$ Stable Single or multiple cables. 	<p>SW-807B-1 SW-807B-3 Patented SW-807B-2 Cable Tunnel Tool</p> <ul style="list-style-type: none"> Slide-able and easy Snap-in Fit Cable within $\varnothing 10\text{mm}$ Can be assembled on both sides Only for SW-801E3 
--	--	---

<p>SW-809-01 Patented Cable Tunnel Tool</p> <ul style="list-style-type: none"> Fit Cable within $\varnothing 5\text{mm}$ Single or double cables. 	<p>SW-809-02 Patented Cable Tunnel Tool</p> <ul style="list-style-type: none"> Slide-able and easy Snap-in Fit Cable within $\varnothing 3.5\text{mm}$ Single or double cables. 	<p>SW-809-03 Supporting Brace</p> <ul style="list-style-type: none"> Material: Stainless Finish: ED black 
---	--	--

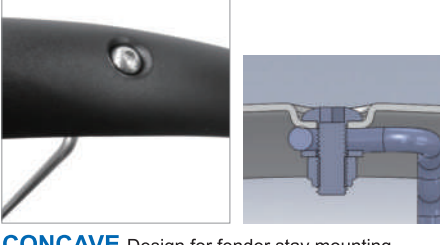

<p>SW-808 Fit Cable within $\varnothing 25\text{mm}$</p> 	<p>SW-804E Washer</p> <ul style="list-style-type: none"> Material: Stainless Finish: ED black For M5 screw 	<p>SW-NP-111 License Plate Holder</p> <ul style="list-style-type: none"> Material: PA6+30%GF Tire fit: 26"-28" P.C & ALU. full-cover applicable. 
--	--	---

APPEARANCE TECHNICAL & FIXTURE

 <p>TAILS SHAPE DESIGN</p>	 <p>CONCAVE Design for fender stay mounting</p>	 <p>POLYESTER NAMEPLATE</p>
--	---	---

COLOR & SURFACE TREATMENT CHART

- Customizable anodize and painting treatment.
- Customizable fender color and length.

 <p>AF-Z01 Black</p>	 <p>AF-M01 Matt Black</p>	 <p>AF-PA01 Fine Sandblasted Black</p>	 <p>AF-S01 Sandblasted Black</p>	 <p>AF-P01 Polished Black</p>	 <p>AF-C01 Coated Red</p>	 <p>AF-R02 Reflective Strap-Centre</p>
 <p>AF-C02 Coated matt black</p>	 <p>AF-C03 Coated matt black with sandblasted</p>	 <p>AF-C04 Coated matt black</p>	 <p>AF-C05 Coated matt black with sandblasted</p>	 <p>AF-D02 Printed on Design</p>	 <p>AF-D01 Design on Coated Surface</p>	 <p>AF-D03 Heat Transfer Printing</p>

SW-FA-311 series

• Material: Aluminum



- FENDER FIXTURES**
SW-8001 | L-Hanger
SW-800J | SW-803V | SW-803N
- FENDER-STAY**
MSA | MSB | MSI | MSV
- STAY-DROPOUT**
TYPE 1 ~ 5

∅5mm

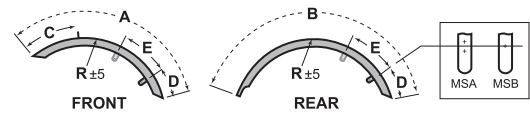
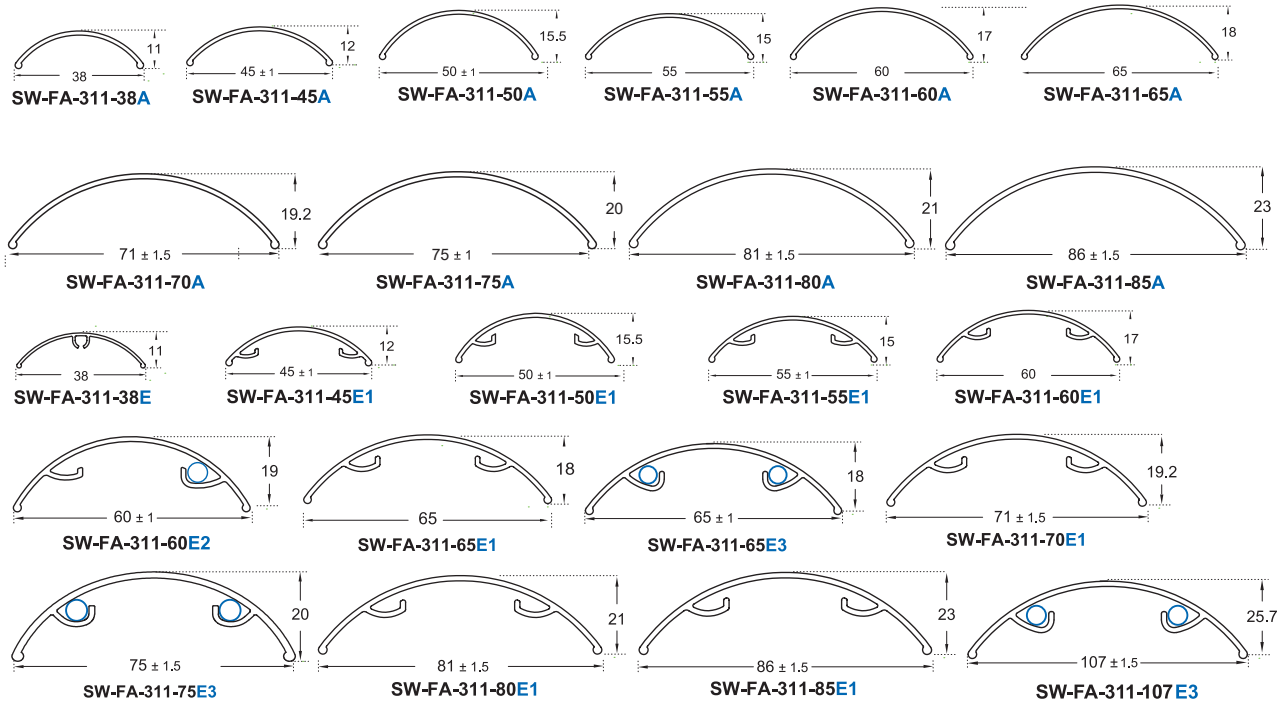

MODEL	SIZE	WIDTH	R	A	B	C	D	E	HANGER	TIRE WIDTH
FA-311-38A FA-311-38E	20"	38mm	275	490	855	145	70	170	800R-G	1" ~ 1.25or 22C ~ 32
	22"		310	525	890	155		195		
	24"		325	575	1010	170		205		
	26"		350	620	1085	185		220		
	650B 700C		370	640	1125	190		240		
	28"		380	640	1125	190		240		
	29"		395	670	1175	195		255		

L-HANGER CHART (Curved Design)

• Material: 304 Stainless Steel

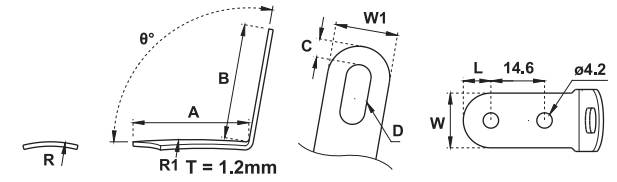

* Standard: SW-8001 for Front Fender / SW-8002 for Rear Fender.

HANGER	θ°	A	B	C	D	L	W	W1	R	R1
*8001	100°	31.5	31.4	5.1	6.8 x 21.5	7.5	15	17	12.9	156.8
*8002	100°	31.3	24.4	4.6	6.8 x 16	7.5	14	16	12.9	156.8
8003	104°	28.5	26	3.3	6.5 x 13	4.5	13	13	12.9	156.8
8004	100°	31.5	25.9	4	6.5 x 15	7.5	15	17	12.9	
8005	100°	31.5	53.8	5	7.5 x 22.5	7.5	15	17.5	30	
8005-2	100°	31.5	53.8	5	9.5 x 22.5	7.5	15	17.5	30	
8006	100°	31.5	38.8	5	7.5 x 22.5	7.5	15	17.5	12.9	156.8
8006-1	100°	31.5	38.8	5	6.8 x 20	7.5	15	17.5	12.9	156.8
8006-4	100°	31.5	38.8	5	5.2 x 22.5	7.5	15	17.5	12.9	156.8
8007	100°	31.3	30.6	5.1	6.8 x 16.5	7.2	12.7	17	12.9	156.8
8007-1	106°	31.3	30.6	5.1	6.8 x 16.5	7.2	12.7	17	12.9	156.8
8008	86°	31.5	31.4	5.1	6.8 x 21.5	7.5	15	17	12.9	156.8
8009	84°	31.5	25.9	4	6.5 x 15	7.5	15	17	12.9	156.8
8010	104°	31.5	31.4	5.1	6.8 x 21.5	7.5	15	17	12.9	156.8
8011	106°	31.5	31.4	5.1	6.8 x 21.5	7.5	15	17	12.9	156.8
8012	110°	31.5	31.4	5.1	6.8 x 21.5	7.5	15	17	12.9	156.8
8014	104°	28.5	31.4	3.3	6.5 x 16.5	4.5	13	13	13	
8015	106°	31	37.5	5	7.5 x 23	7.5	15	17.5	12.9	156.8
8017	92°	31.3	24.4	4.6	6.8 x 16	7.5	14	16	12.9	320
8018	92°	31.5	31.4	5.1	6.8 x 21.5	7.5	15	17	12.9	156.8
8019	84°	31.5	36	5	6.8 x 26	7.5	15	17.5	12.9	156.8
8019-1	100°	31.5	36	5	6.8 x 26	7.5	15	17.5	12.9	156.8
8022	90°	31.6	31.4	5	6.8 x 24.5	7.5	14.5	17	17	371.27 * only for FE-131
8023	90°	29.5	26	4.3	6.8 x 18	4.5	18	18	185	* only UPPER
8024	90°	29.5	19.3	4.3	6.8 x 11	4.5	18	18	185	* only UPPER

L-HANGER CHART (Flat Design)

• Material: 304 Stainless Steel

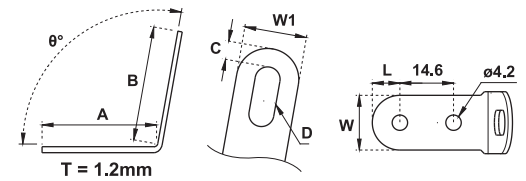

* Standard: SW-815 for Front Fender / SW-8002-1 for Rear Fender.

HANGER	θ°	A	B	C	D	L	W	W1	R	R1
8002-1	100°	31.3	24.4	4.6	6.8 x 16	7.5	14	16		
8005-1	120°	31.5	53.8	5	7.5 x 22.5	7.5	15	17.5		
8006-2	77°	31.5	38.8	5	7.5 x 22.5	7.5	15	17.5		
8006-3	85°	31.5	38.8	5	7.5 x 22.5	7.5	15	17.5		
8020	90°	31.4	27	5.1	6.5 x 17	7.5	15	17		156.8
815	100°	31.5	32	5.1	6.8 x 15.5	7.5	15	17		
815-1	100°	38.9	24	5.1	6.8 x 15.5	7.5	15	17		
8021	92°	31.5	24	4.6	6.8 x 16	7.5	14	16		

SW-FA-511-30 / 37 / 45 / 65

• Material: Aluminum

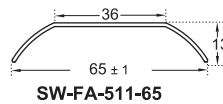
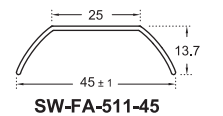
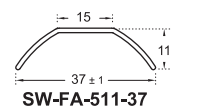
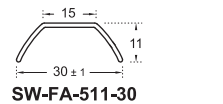

FENDER FIXTURES

SW-815 | L-Hanger

FENDER-STAY

MSA | MSB | MSI | MSV

STAY-DROPOUT

TYPE 1 ~ 5



Sleek Look on Roadbike

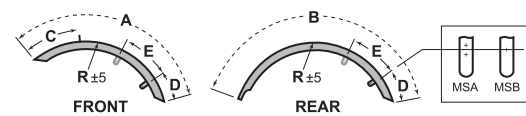

MODEL	SIZE	WIDTH	R	A	B	C	D	E	HANGER	TIRE WIDTH
FA-511-30	20"	30mm	275	490	855	145	70	170	SW-800P-A	20C ~ 25C
	22"		310	525	890	155		195		
	24"		325	575	1010	170		205		
	26"		350	620	1085	185		220		
	650B 700C		370	640	1125	190		240		
	28"		380	640	1125	190		240		
	29"		395	670	1175	195		255		
FA-511-37	20"	37mm	275	490	855	145	70	170	SW-800P-B	1" ~ 1.125" or 22C ~ 28C
	22"		310	525	890	155		195		
	24"		325	575	1010	170		205		
	26"		350	620	1085	185		220		
	650B 700C		370	640	1125	190		240		
	28"		380	640	1125	190		240		
	29"		395	670	1175	195		255		

SW-FA-311 series

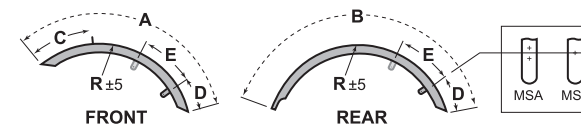

MODEL	SIZE	WIDTH	R	A	B	C	D	E	HANGER	TIRE WIDTH
FA-311-45A FA-311-45E1	20"	45mm	275	490	855	145	70	170	SW-800R-F	1.125" ~ 1.5" or 32C ~ 38C
	22"		310	525	890	155		195		
	24"		325	575	1010	170		205		
	26"		350	620	1085	185		220		
	650B 700C		370	640	1125	190		240		
	28"		380	640	1125	190		240		
	29"		395	670	1175	195		255		
FA-311-50A FA-311-50E1	20"	50mm	275	490	855	145	70	170	800S-A	1.35" ~ 1.75" or 35C ~ 40C
	22"		310	525	890	155		195		
	24"		325	575	1010	170		205		
	26"		350	620	1085	185		220		
	650B 700C		370	640	1125	190		240		
	28"		380	640	1125	190		240		
	29"		395	670	1175	195		255		
FA-311-55A FA-311-55E1	20"	55mm	275	490	855	145	70	170	SW-800J	1.5" ~ 1.9" or 40C ~ 45C
	22"		310	525	890	155		195		
	24"		325	575	1010	170		205		
	26"		350	620	1085	185		220		
	650B 700C		370	640	1125	190		240		
	28"		380	640	1125	190		240		
	29"		395	670	1175	195		255		
FA-311-60A FA-311-60E1	20"	60mm	275	490	855	145	70	170	800R-I	1.75" ~ 2.125" or 45C
	22"		310	525	890	155		195		
	24"		325	575	1010	170		205		
	26"		350	620	1085	185		220		
	650B 700C		370	640	1125	190		240		
	28"		380	640	1125	190		240		
	29"		395	670	1175	195		255		
FA-311-60E2	20"	60mm	275	490	855	145	70	170	800R-I	1.75" ~ 2.125" or 45C
	22"		310	525	890	155		195		
	24"		325	575	1010	170		205		
	26"		350	620	1085	185		220		
	650B 700C		370	640	1125	190		240		
	28"		380	640	1125	190		240		
	29"		395	670	1175	195		255		
FA-311-65A FA-311-65E1 FA-311-65E3	20"	65mm	275	490	855	145	70	170	800R-H	1.9" ~ 2.2"
	22"		310	525	890	155		195		
	24"		325	575	1010	170		205		
	26"		350	620	1085	185		220		
	650B 700C		370	640	1125	190		240		
	28"		380	640	1125	190		240		
	29"		395	670	1175	195		255		
FA-311-70A FA-311-70E1	20"	70mm	275	490	855	145	70	170	800R-K	2.10" ~ 2.5"
	22"		310	525	890	155		195		
	24"		325	575	1010	170		205		
	26"		350	620	1085	185		220		
	650B 700C		370	640	1125	190		240		
	28"		380	640	1125	190		240		
	29"		395	670	1175	195		255		
FA-311-75E3	20"	75mm	275	490	855	145	70	170	N/A	2.35" ~ 2.7"
	22"		310	525	890	155		195		
	24"		325	575	1010	170		205		
	26"		350	620	1085	185		220		
	650B 700C		370	640	1125	190		240		
	28"		380	640	1125	190		240		
	29"		395	670	1175	195		255		
FA-311-80A FA-311-80E1	20"	80mm	275	490	855	145	70	170	800R-L	2.5" ~ 2.7"
	22"		310	525	890	155		195		
	24"		325	575	1010	170		205		
	26"		350	620	1085	185		220		
	650B 700C		370	640	1125	190		240		
	28"		380	640	1125	190		240		
	29"		395	670	1175	195		255		
FA-311-85A	20"	85mm	275	490	855	145	70	170	N/A	2.6" ~ 2.8"
	22"		310	525	890	155		195		
	24"		325	575	1010	170		205		
	26"		350	620	1085	185		220		
	650B 700C		370	640	1125	190		240		
	28"		380	640	1125	190		240		
	29"		395	670	1175	195		255		
FA-311-85E1	20"	85mm	275	490	855	145	70	170	N/A	2.7" ~ 3"
	22"		310	525	890	155		195		
	24"		325	575	1010	170		205		
	26"		350	620	1085	185		220		
	650B 700C		370	640	1125	190		240		
	28"		380	640	1125	190		240		
	29"		395	670	1175	195		255		
FA-311-107E3	20"	107mm	275	490	855	145	70	170	N/A	3.7" ~ 4.0"
	22"		310	525	890	155		195		
	24"		325	575	1010	170		205		
	26"		350	620	1085	185		220		
	650B 700C		370	640	1125	190		240		
	28"		380	640	1125	190		240		
	29"		395	670	1175	195		255		

SW-FA-513 series

• Material: Aluminum

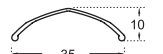

SW-FA-513-35

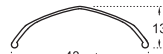

SW-FA-513-43

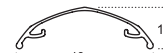

SW-FA-513-43E1



SW-FA-513-50

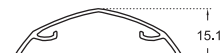

SW-FA-513-50E1



SW-FA-513-55



SW-FA-513-55E1



SW-FA-513-60



SW-FA-513-60E1



FENDER FIXTURES

SW-8001 | L-Hanger

FENDER-STAY

MSA | MSB | MSI | MSV

STAY-DROPOUT

TYPE 1 ~ 5

SW-FA-511-30 / 37 / 45 / 65

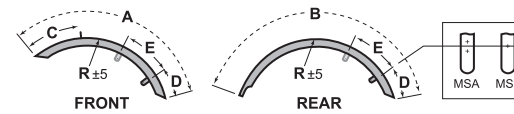

MODEL	SIZE	WIDTH	R	A	B	C	D	E	HANGER	TIRE WIDTH
FA-511-45	20"	45mm	275	490	855	145	70	170	SW-800R-B	1.125" ~ 1.5" or 32C ~ 38C
	22"		310	525	890	155		195		
	24"		325	575	1010	170		205		
	26"		350	620	1085	185		220		
	650B 700C		370	640	1125	190		240		
	28"		380	640	1125	190		240		
29"	395	670	1175	195	255					
FA-511-65	20"	65mm	275	490	855	145	70	170	800R-J	1.9" ~ 2.2"
	22"		310	525	890	155		195		
	24"		325	575	1010	170		205		
	26"		350	620	1085	185		220		
	650B 700C		370	640	1125	190		240		
	28"		380	640	1125	190		240		
29"	395	670	1175	195	255					

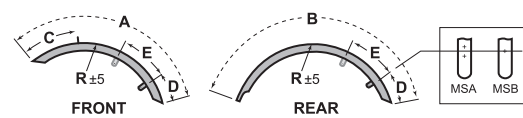

MODEL	SIZE	WIDTH	R	A	B	C	D	E	HANGER	TIRE WIDTH
FA-513-35	20"	35mm	275	490	855	145	70	170	SW-800S-C	1" ~ 1.125" or 20C ~ 28C
	22"		310	525	890	155		195		
	24"		325	575	1010	170		205		
	26"		350	620	1085	185		220		
	650B 700C		370	640	1125	190		240		
	28"		380	640	1125	190		240		
29"	395	670	1175	195	255					

SW-FA-515-45 / 50

• Material: Aluminum / Leather

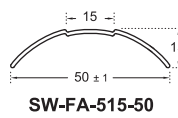
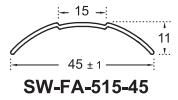

*Optional Leather Strap.

FENDER FIXTURES

SW-800I | L-Hanger

FENDER-STAY

MSA | MSB | MSI | MSV

STAY-DROPOUT

TYPE 1 ~ 5



Elegant Look on Bikes

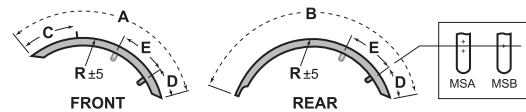

MODEL	SIZE	WIDTH	R	A	B	C	D	E	HANGER	TIRE WIDTH
FA-515-45	20"	45mm	275	490	855	145	70	170	SW-800R-D	1.125" ~ 1.5" or 32C ~ 38C
	22"		310	525	890	155		195		
	24"		325	575	1010	170		205		
	26"		350	620	1085	185		220		
	650B 700C		370	640	1125	190		240		
	28"		380	640	1125	190		240		
	29"		395	670	1175	195		255		
FA-515-50	20"	50mm	275	490	855	145	70	170	SW-800S-B	1.35" ~ 1.75" or 35C ~ 40C
	22"		310	525	890	155		195		
	24"		325	575	1010	170		205		
	26"		350	620	1085	185		220		
	650B 700C		370	640	1125	190		240		
	28"		380	640	1125	190		240		
	29"		395	670	1175	195		255		

SW-FA-513 series

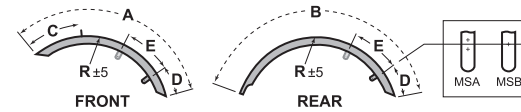

MODEL	SIZE	WIDTH	R	A	B	C	D	E	HANGER	TIRE WIDTH
FA-513-43 FA-513-43E1	20"	43mm	275	490	855	145	70	170	SW-800R-C	1.1" ~ 1.45" or 28C ~ 35C
	22"		310	525	890	155		195		
	24"		325	575	1010	170		205		
	26"		350	620	1085	185		220		
	650B 700C		370	640	1125	190		240		
	28"		380	640	1125	190		240		
	29"		395	670	1175	195		255		
FA-513-50 FA-513-50E1	20"	50mm	275	490	855	145	70	170	SW-800S-A	1.35" ~ 1.75" or 35C ~ 40C
	22"		310	525	890	155		195		
	24"		325	575	1010	170		205		
	26"		350	620	1085	185		220		
	650B 700C		370	640	1125	190		240		
	28"		380	640	1125	190		240		
	29"		395	670	1175	195		255		
FA-513-55 FA-513-55E1	20"	55mm	275	490	855	145	70	170	SW-800S-D	1.5" ~ 1.9" or 40C ~ 45C
	22"		310	525	890	155		195		
	24"		325	575	1010	170		205		
	26"		350	620	1085	185		220		
	650B 700C		370	640	1125	190		240		
	28"		380	640	1125	190		240		
	29"		395	670	1175	195		255		
FA-513-60 FA-513-60E1	20"	60mm	275	490	855	145	70	170	SW-513-60	1.75" ~ 2.125" or 45C
	22"		310	525	890	155		195		
	24"		325	575	1010	170		205		
	26"		350	620	1085	185		220		
	650B 700C		370	640	1125	190		240		
	28"		380	640	1125	190		240		
	29"		395	670	1175	195		255		

SW-FA-517 series

• Material: Aluminum

FENDER-STAY

MSI

STAY-DROPOUT

804H-4

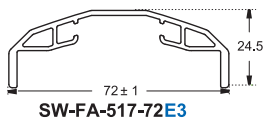
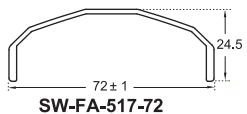
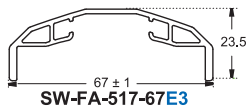
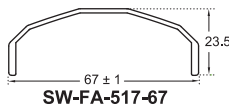

Cable Tunnel
(Fit Cable within ø5mm)

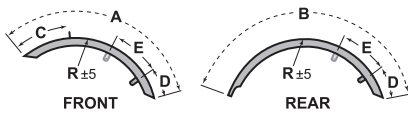

MODEL	SIZE	WIDTH	R	A	B	C	D	E	HANGER	TIRE WIDTH
FA-517-67 FA-517-67E3	20"	67mm	275	490	855	145	70	170	N/A	2"~2.4"
	22"		310	525	890	155		195		
	24"		325	575	1010	170		205		
	26"		350	620	1085	185		220		
	650B 700C		370	640	1125	190		240		
	28"		380	640	1125	190		240		
FA-517-72	20"	72mm	275	490	855	145	70	170	N/A	2.2"~2.6"
	650B 700C		370	640	1125	190		240		
FA-517-72E3	20"	72mm	275	490	855	145	70	170	N/A	2.2"~2.6"
	22"		310	525	890	155		195		
	24"		325	575	1010	170		205		
	26"		350	620	1085	185		220		
	650B 700C		370	640	1125	190		240		
	28"		380	640	1125	190		240		
29"	395	670	1175	195	255					

BAMBOO FENDER PROFILE

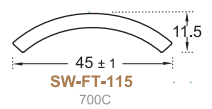

TIRE-WIDTH CHART

28C		
1.125"		
1.25"		
32C	SW-FT-115	
1.35"		
1.375"		
35C		
1.45"	(W: 45mm)	
38C		
1.5"		
40C		
1.6"		

TIRE-FIT CHART

MODEL	12"	14"	16"	18"	20"	22"	24"	26"	700C	28"	29"
FT-115									•		

FENDER STAY MOUNTING (FIXED)

SELECTIVE STAY THICKNESS
All fender stay are available in ø3.2mm and ø4.0mm thickness to meet different needs.
Material: • 204 / 304 Stainless Steel: ø3.2 and ø4.0mm
• Steel (ED Black): ø4.0mm

SELECTIVE STAY EYELET DIAMETER

MSI
SINGLE-STAY + MOUNTED BRACKET
Single fender stay mounted to both sides of fenders with stainless steel under bracket.

MSV
V-STAY + MOUNTED BRACKET
V-style fender stay mounted to both sides of fenders with stainless steel under bracket.
*Recommendable for FRONT & REAR fenders.

FENDER STAY SAFETY POP-OFF

STAY SAFETY	DESCRIPTION	FIT STAY	FUNCTION
	<p>FV-515 Patented (For ø3.2 / ø4 mm FENDER-STAY) FENDER STAY SAFETY POP-OFF Applicable to MSA / MSB / MSI / MSV fender-stays to pop-off when jammed.</p>	<p>MSA MSB MSI MSV</p>	

Bamboo

Full-cover Fender Natural material has been widely used nowadays as in response to the issue of environment. Bamboo is one of the fastest growing plants in the world, and is of notable economic and Oriental culture significance. Unlike any other industrial products, Bamboo is fully decomposable and produces almost no pollution during production and after its life cycle. The natural fiber of Bamboo makes Bamboo fender a durable and eco-friendly product for bicycle.



SW-FT-115

- Made of real, natural bamboo.
- Environmental-friendly & Retro-style look.

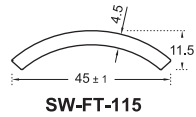

FENDER FIXTURES

SW-8001 | L-Hanger
SW-800R-E

FENDER-STAY

MSI | MSV

STAY-DROPOUT

TYPE 1 ~ 5



Optional Leather Fender-tail



Retro Look on Bikes

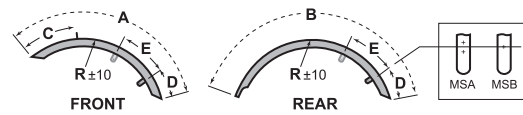

MODEL	SIZE	WIDTH	R	A	B	C	D	E	HANGER	TIRE WIDTH
FT-115	700C	45mm	370	640	1125	190	70	240	SW-800R-E	1.125" ~ 1.375" (1-1/8" ~ 1-3/8") or 28C ~ 35C

FENDER FIXTURES

	SW-802A HANGER-BRIDGE WASHER Material: PP R7mm recessed to fit bridge tube.		SW-802B HANGER-FORK WASHER Material: PP R14.5mm recessed to fit fork sleeve tube.
	SCBM-1 STANDARD FENDER-CHAINSTAY BRIDGE MOUNT (For Fender Width within 55mm.) • Bolt fixes between fender and chainstay bridge.		

FENDER FIXTURES

	STAINLESS STEEL SELF-BEND HANGER Material: Stainless Steel SW-800R / SW-800S / SW-800R-E
--	---

FENDER TAILS

FIX	MATERIAL	FENDER TAIL	MODEL	FIT FENDER
RIVET FIX	LEATHER		SW-803J	SW-FT-115

L-HANGER CHART (Curved Design)

• Material: 304 Stainless Steel

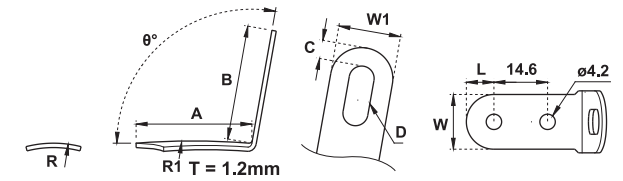

* Standard: SW-8001 for Front Fender.

HANGER	θ°	A	B	C	D	L	W	W1	R	R1
8001	100°	31.5	31.4	5.1	6.8 x 21.5	7.5	15	17	12.9	156.8

L-HANGER CHART (Flat Design)



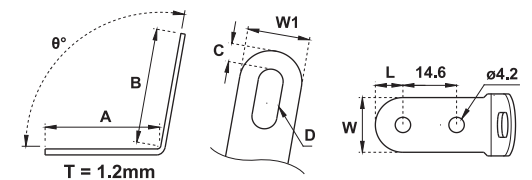



• Material: 304 Stainless Steel



* Standard: SW-815 for Front Fender.

HANGER	θ°	A	B	C	D	L	W	W1	R	R1
815	100°	31.5	32	5.1	6.8 x 15.5	7.5	15	17		

SEAT POST CLAMPS

<p>QR Quick-release "Clip-in" Clamp</p>  <p>To fit $\varnothing 18.5 - 22.2$ mm seat post. (Exclusively made for SW-669R)</p>	<p>SW-64A2 Hinged Clamp</p>  <p>To fit $\varnothing 25 - 32$ mm seat post.</p>	<p>SW-64F2 (Standard)</p>  <p>To fit $\varnothing 25 - 32$ mm seat post.</p>	<p>SW-64F3 Clamp</p>  <p>To fit $\varnothing 32 - 40$ mm seat post.</p>
<p>SW-64D2 Clamp with Fixed Bridge</p>  <p>To fit $\varnothing 25 - 32$ mm seat post.</p>	<p>SW-64H2 Quick-release "Strap" Clamp</p>  <p>To fit $\varnothing 25 - 38$ mm seat post.</p>	<p>SW-64H3 Quick-release "Adjustable" Clamp with plastic screw</p>  <p>To fit $\varnothing 25 - 38$ mm seat post.</p>	<p>SW-64H3-1 Quick-release "Adjustable" Clamp with plastic screw</p>  <p>To fit $\varnothing 25 - 38$ mm seat post.</p>
<p>SW-64H5 Quick-release "Strap" Clamp with Rubber</p>  <p>To fit $\varnothing 25 - 38$ mm seat post.</p>			

Extension Connector

<p>64C1 (Standard) Length: 70 mm.</p> 	<p>64C2 Length: 100 mm.</p> 	<p>64C3 Length: 130 mm.</p> 	<p>64C4 Length: 70 mm.</p> 	<p>64C5 Length: 100 mm.</p> 
--	--	--	--	--

MUDGUARD CONNECTOR & BRACKETS

SB1 Inner Head-tube Connector
To fix with DHKA and/or DHKB brackets.
Head tube $\varnothing 18.5 - 22.2$ mm / $\varnothing 22.2 - 25.4$ mm



STEP 1: Insert connector into head tube.
STEP 2: Push down to lock.
STEP 3: Attach bracket.

DHKA / DHKB Front Brackets
To connect with Down-hill front fender S and/or L.
(Compatible also with SB1)



J1 Front Bracket
To fix to the front of uni-crown fork.
(For 18" ~ 26" bikes)



J3 Rear Bracket
To fix to seat stay bridge with caliper or V-brakes.



J2 Bracket
To fix to the rear of uni-crown fork or on seat stay bridge without brake.
Angle 116° (For 18" & 20" bikes)



J4 Bracket
To fix to the rear of uni-crown fork or on seat stay bridge without brake.
Angle 108° (For 20", 24" & 26" bikes)



SB1-D Inner Head-tube Connector
For SW-FI-661NF / 669F1 / 669NF / 671NF / 133F / 135F / 153F
Head tube $\varnothing 18.5 - 34.5$ mm



SB5-01 Inner Head-tube "Quick-release" connector
(Fit inner diameter $\varnothing 18.5 / 22.2 / 25.4 / 31.8 - 34.5$ mm)
For SW-661NF / SW-669F1 / SW-669NF / SW-671NF



SB113 Inner Head-tube Connector
Head tube $\varnothing 22.2$ mm / $\varnothing 18.5 - 22.2$ mm / $\varnothing 22.2 - 25.4$ mm / $\varnothing 31.8 - 34.5$ mm (D)



STEP 1: Insert connector into head tube.
STEP 2: Push down to lock.
STEP 3: Attach bracket.

SB9 Inner Head-tube Connector
For SW-FI-155FR-A / SW-FI-155F/R-B
Head tube $\varnothing 18.5 - 34.5$ mm



SW-663F(FN)/CR(HR) Quick-release Mudguard

- Material: PP
- SW-663F front mudguard with rubber strap to quickly wrap on any fork.
- SW-663FN front mudguard with stainless steel connector.
- SW-663CR rear mudguard with 64F2 fixed clamp to fit $\varnothing 32 \sim 40\text{mm}$ seat-post.
- SW-663HR rear mudguard with 64H2 quick-release clamp to fit $\varnothing 25 \sim 38\text{mm}$ tubes.
- Lightweight and durable.
- Rear mudguard angle adjustable.



SW-670F(QF)/R(QR) Quick-release Mudguard

- Material: PP
- SW-670F/R combined with 67S1F stainless steel connector.
- SW-670QF/QR combined with 67Q1F stainless steel connector.
- Quick setup and release to fork sleeve.
- Lightweight and durable.
- SW-6705L bracket designed for Shimano BR 5800 Dual pivot system.

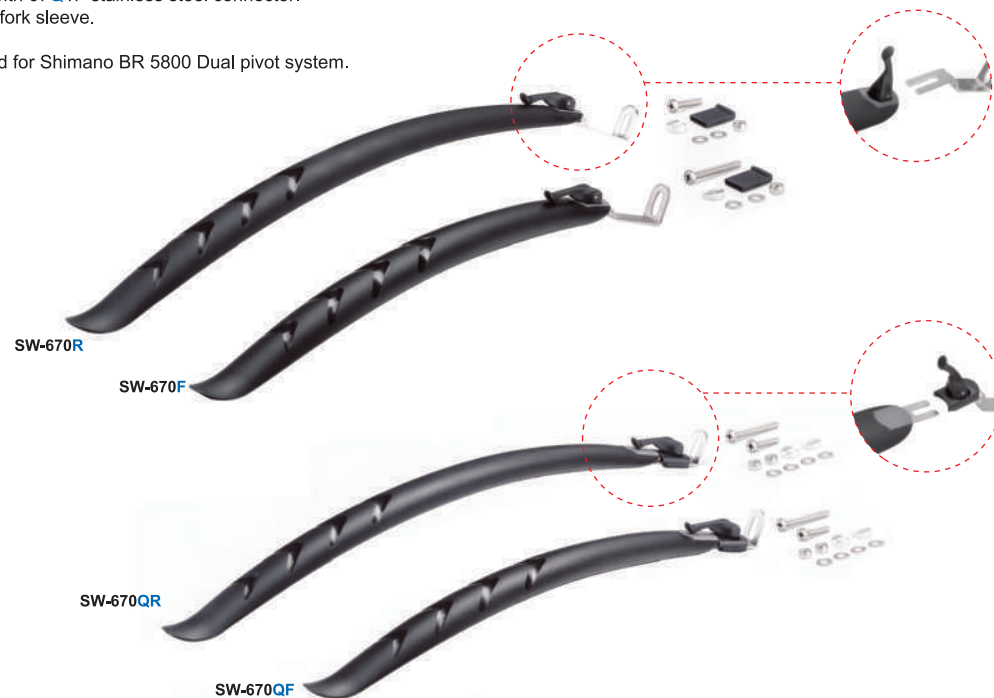

FENDER STAY MOUNTING (FIXED)

SELECTIVE STAY THICKNESS
All fender stay are available in $\varnothing 3.2\text{mm}$ and $\varnothing 4.0\text{mm}$ thickness to meet different needs.

Material: • 204 / 304 (Natural, ED): $\varnothing 3.2$ and $\varnothing 4.0\text{mm}$
• Steel (CP, ED): $\varnothing 4.0\text{mm}$

SELECTIVE STAY EYELET DIAMETER

$\varnothing 5\text{mm} \begin{matrix} +0.3 \\ -0.1 \end{matrix}$	$\varnothing 6\text{mm} \begin{matrix} +0.3 \\ -0.1 \end{matrix}$	$\varnothing 8\text{mm} \begin{matrix} +0.3 \\ -0 \end{matrix}$	$\varnothing 10\text{mm} \begin{matrix} +0.3 \\ -0.1 \end{matrix}$
---	---	---	--

MSB
FENDER STAY + SAFETY QR FASTENER 804N
Fender stay mounted to the interior of fenders with SW-804N under bracket.
For SW-FI-151FR / SW-FI-171FR / SW-FI-173FR / SW-FI-175FR / SW-FI-117FR

POI
SINGLE-STAY + SAFETY QR FASTENER
Widely used for front fender installation.
Stay accompanies selective QR fastener: (POPOFF5)

POV
V-STAY + SAFETY QR FASTENER
For both front and rear fender installation.
Stay accompanies selective QR fastener: (POPOFF5)
*stand $\varnothing 40$

POP OFF 5
SAFETY QR FASTENER (For $\varnothing 3.2 / \varnothing 4$ mm FENDER-STAY)
Material: POM
Safety design to detach in accident and prevent jamming the wheel.
(QR) quick release, easy installation and allows 20mm stay length adjustment.

FENDER STAY HARDWARE

804N Pat.
Easy installation
Polyester nameplate
Fit $\varnothing 4\text{mm}$ fender stay.
For SW-FI-151FR / SW-FI-171FR
SW-FI-173FR / SW-FI-175FR
SW-FI-117FR

804N-01
Material: TPR
Pad underneath the 804N
in order to fit curved surface.

Optional
Color: BLACK

FENDER STAY SAFETY POP-OFF

STAY SAFETY	MODEL	FIT STAY	STAY
 POP OFF5	SAFETY QR FASTENER (For $\varnothing 3.2 / \varnothing 4$ mm FENDER-STAY) INJECTED FENDER ONLY Safety design to detach in accident and prevent jamming the wheel. (QR) quick release, easy installation and allows 20mm stay length adjustment. Designed for : SW-655, SW-656, FI-117, FI-173, SW-615, SW-668, FI-111, FI-171	POI POV	 Auto-detach When Jammed
	FV-515 Patented FENDER STAY SAFETY POP-OFF Applicable to MSB fender-stays to pop-off when jammed.	MSB	

SW-FI-157 Down-tube Mudguard (For Road-bike)

- Material: PP / TPR
- Soft TPR material to fit different shape of down-tubes.
- Special buckle with Velcro-tie fixation for easy installation and release.



Design for Roadbike



Special buckle fixation

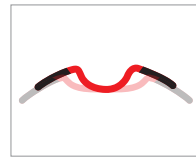

Elastic material to fit all tubes

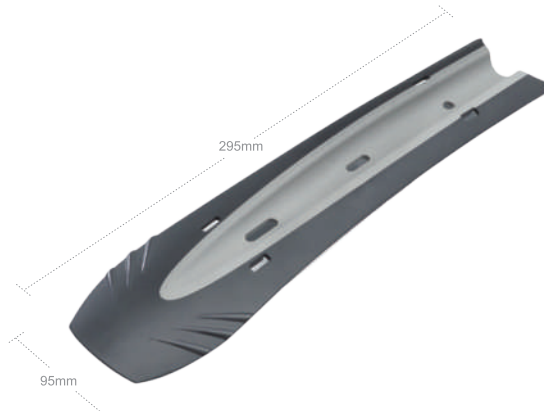

Packaged Size:
L 710 x W 200mm.

SW-PS1F/R Refoldable Quick-release Mudguard

- Material: PA6



"Clip-in" Front Mudguard

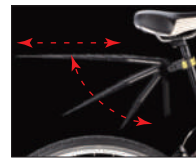

Adjustable Rear Mudguard



Safety Reflective Stickers

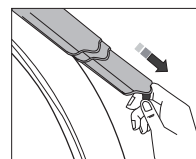

Refoldable Design



FRONT MUDGUARD FIX

(Standard)
SW-S1
Fix to the BACK of fork sleeve

SW-67S1F
Fix to the FRONT of fork sleeve

SW-SB1
Fix to the INSIDE of steer tube

SW-FI-119F(F1)/R(R1) Quick-release Mudguard

- Material: PP
- Minimal design to suit all style of bikes.
- Effective mud stop.
- Easy installation.
- Tough and durable.
- Optional SW-FI-119F1/R1 with wider mudguard-tail.



Front Fender



Rear Fender



SW-FI-119F/R



FI-119F/R Mudguard Tail



FI-119F1/R1 Mudguard Tail



SW-FI-119F1/R1
(Wider mudguard-tail)

SW-FI-131CR(HR) Quick-release Mudguard

- Material: PP
- Minimal design to suit all style of bikes.
- Effective mud stop.
- Easy installation.
- Tough and durable.
- FI-131CR with 64F2 fixed clamp to fit $\varnothing 25 \sim 32$ mm seat-post.
- FI-131HR with 64H2 quick-release clamp to fit $\varnothing 25 \sim 38$ mm tubes.

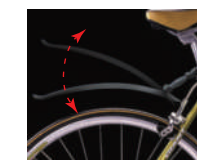

Rear Mudguard



SW-FI-131CR

SW-FI-131HR



64F2
Fixed Clamp

- Fit $\varnothing 25 \sim 32$ mm seat-post.



64H2
Quick-release "Strape" Clamp

- Fit $\varnothing 25 \sim 38$ mm seat-post.



64H3-1
Quick-release "Adjustable" Clamp with Plastic Screw

- Fit $\varnothing 25 \sim 38$ mm seat-post.



64H5
Quick-release "Strape" Clamp

- QR Slide-release Clamp • Fit $\varnothing 25 \sim 32$ mm seat-post.
- Fit $\varnothing 25 \sim 38$ mm seat-post.

SW-DH7 Down-hill Mudguard

- Material: PP
- Aerodynamic design.
- Effective over-width mud stop.
- Easy installation.
- Tough and durable.



Front Mudguard



Rear Mudguard



SW-613F/R Mudguard

- Material: PP
- Fit uni-crown fork Cantilever brake style.
- Fit $\phi 28.6 \sim \phi 31.8$ mm seat-tube.
- Slide in and fix.



Front Mudguard



Rear Mudguard



SW-613 Slide-fix Hanger

SW-DH5 Down-hill Mudguard

- Material: PP
- Muscular look.
- Easy installation.
- Tough and durable.
- Widest combination to fit from 16" ~ 26" bikes.



DHKA + DHKB



SW-DH5L+S
Fit $\phi 18.5 \sim 25.4$ mm Inner Stem



SW-64A2



Fit $\phi 25 \sim 32$ mm Seat Post



SW-64D2



Fit $\phi 25 \sim 32$ mm Seat Post
w/ Built-in Clamp on Bridge

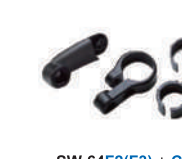

SW-64F2(F3) + C1



SW-64F2 - Fit $\phi 25 \sim 32$ mm
SW-64F3 - Fit $\phi 32 \sim 40$ mm



SW-64H2(H3) + C2

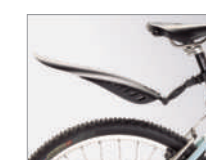

Fit $\phi 25 \sim 38$ mm Seat Post

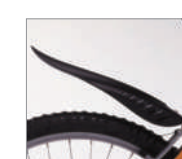

SW-DH5R - with J3 Bracket
to Fit on Seat-stay Bridge



SW-DH5L+S
with J1 & J4 Brackets
to Fit on Uni-crown Fork



J1~J4 Brackets for DH5

Wheel Size	Mudguard Selection	Fitting
12"	DH5T	
16"	DH5S+T	Fit on seat post (Rear Mudguard)
20"	DH5R	Fit on bridge (Rear Mudguard)
	DH5L	
	DH5S	Front Mudguard
24"~26"	DH5L+S+R	Front & Rear Mudguards

SW-651F/R Mudguard

- Material: PP
- Tough, durable and effective mud stop.
- Selective hardware for variety of bikes.
- Hardware bendable to fit.



Front Mudguard



Rear Mudguard



SW-651 REAR MUDGUARD HARDWARE

• Material: ED Steel



- Standard**
- Fit rear cantilever brake.
 - Mount bridge or bridge-plate.
 - Fit ATB recommended.



- SW-651-V1**
- Fit rear cantilever / long arm V-brake.
 - Mount bridge or bridge-plate.



- SW-651-V3 / 659**
- Fit rear V-brake.
 - Mount bridge or bridge-plate.



- SW-651-D1**
- Fit rear drum brake.
 - Mount bridge or bridge-plate.



- SW-651-L1**
- Fit side lock bikes only.
 - Mount bridge or bridge-plate.

SW-654(640)F/R Mudguard

- Material: PP
- For full-suspension XC bikes.
- Angle adjustable rear mudguard hardware.
- Front mudguard length adjustable.



Front Mudguard



Rear Mudguard

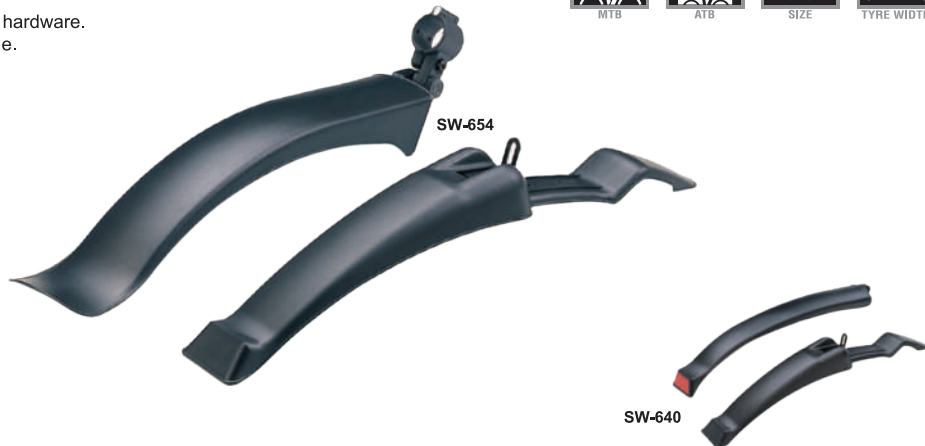

Front Mudguard Hanger



- SW-640 Slide-fix Hanger**
- Material: ED Steel
 - Fit uni-crown fork with Cantilever & V-brake.
 - Slide-in and fix.
 - 4-position adjustable.

Rear Mudguard Seat Post Bracket



- SW-64A2**
- Hinged clamp for ø25 ~ 32mm seatpost.



- SW-64D2**
- Hinged clamp for ø25 ~ 32mm seatpost.

- SW-64F2 / SW-64F3**
- SW-64F2: ø25~32mm clamp Mounting on seat post
 - SW-64F3: ø32~40mm clamp Mounting on seat post.

SW-641F/R Mudguard

- Material: PP
- Fit uni-crown fork Cantilever brake style.
- Fit ø28.6 ~ ø31.8mm seat-tube.
- Slide in and fix.
- 4 position adjustable.



Front Mudguard



Rear Mudguard



SW-616 Slide-fix Hanger

SW-642F/R(RL) Mudguard

- Material: PP
- Angle adjustable rear mudguard hardware SW-64A2 to fit ø25~32mm seat post.
- Optional SW-642RL extendable rear mudguard for better mud stop.



Front Mudguard



Rear Mudguard



Extendable Rear Mudguard



SW-642RL

SW-669CR Quick-release Mudguard

- Material: PP
- Angle adjustable.
- Optional 64C series mudguard bridge.



Rear Mudguard



Selective Color (MOQ: 500sets)



SW-669F1/R1 Quick-release Mudguard

- Material: PP
- Suitable for suspension fork.



Easy to install with SB1-D

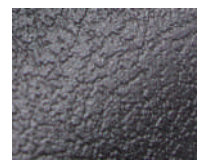

Leather Texture



Front Mudguard



Rear Mudguard



SB1-D Exclusive Hardware

• Click fix on the BOTTOM of inner head tube.

Use Head tube(mm)	SB1-D	SB1-D	SB1-D	SB1-D
$\phi 22.2$	•			
$\phi 25.4$	•	•		
$\phi 28.6$	•		•	
$\phi 31.8$	•			•
$\phi 34.5$	•	•		•

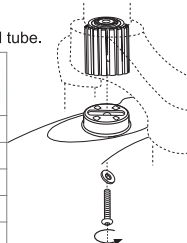

SW-655F/R(R1/RL) Mudguard

- Material: PP
- Fit uni-crown fork Cantilever & V-brake.
- Cable-friendly seat-tube clip design.
- Fit 5/8" or 1/2" seat-stay bridge.
- Cable-friendly clip to fit $\phi 28.6 \sim 31.8$ mm seat tube.
- Mud-flap design for better mud stop.
- Optional SW-655R1 (without steel clip) and SW-655RL (Larger mud-flap) rear mudguard.



Easy-release Knob



Front Mudguard



Cable-friendly Seat-tube Clip



Rear mudguard

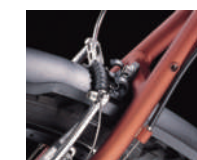

2-way Mudguard Bracket



SW-661NF+CR Quick-release Mudguard

- Material: PP + TPR
- Suitable for suspension fork.
- Quick-release front mudguard.
- Angle adjustable rear mudguard with fixed clamp.



Easy to install with SB1-D



Front Mudguard



Rear Mudguard



SB1-D Exclusive Hardware

• Click fix on the BOTTOM of inner head tube.

Use Head tube(mm)	SB1-D	SB1-D	SB1-D	SB1-D
$\phi 22.2$	•			
$\phi 25.4$	•	•		
$\phi 28.6$	•		•	
$\phi 31.8$	•			•
$\phi 34.5$	•	•		•

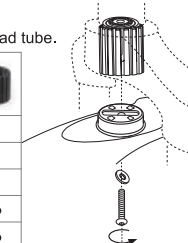

SW-1001 Down-tube Mudguard

- Material: PP / ABS
- Selective fix types:
SW-1001A: Pre-bolted fix.
SW-1001C: Rubber tie fix.
- Quick and easy setup.
- Lightweight and durable.



A Pre-bolted



C Rubber Tie



SW-1001T

- For pre-bolted down tubes only.



SW-1001S

- For pre-bolted down tubes only.



FI-113F Quick-release Mudguard (match to sw-669R)

- Material: PP
- Multiple Color Selection
- 4-position Adjustable (17.5mm)



Front Mudguard



SB-113
Exclusive Hardware

- Click fix on the BOTTOM of inner head tube.
- Fit $\phi 18.5 \sim 22.2\text{mm}$ / $\phi 22.2 \sim 25.4\text{mm}$ / $\phi 31.8 \sim 34.5\text{mm}$.

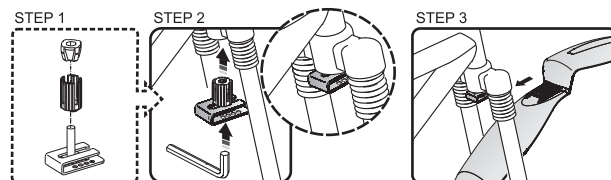

SW-669NF Quick-release Mudguard

- Material: PP

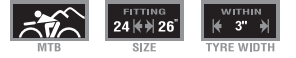

Front Mudguard



SB5-01
Exclusive Hardware

- Click fix on the BOTTOM of inner head tube.
- Fit $\phi 18.5 \sim 22.2\text{mm}$ / $\phi 22.2 \sim 25.4\text{mm}$ / $\phi 31.8 \sim 34.5\text{mm}$.

SB1-D Exclusive Hardware

- Click fix on the BOTTOM of inner head tube.

Use Head tube(mm)				
$\phi 22.2$	•			
$\phi 25.4$	•	•		
$\phi 28.6$	•		•	
$\phi 31.8$	•			•
$\phi 34.5$	•	•		•

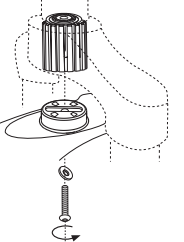

SW-671NF/HR Quick-release Mudguard

- Material: PP + TPR
- Suitable for suspension fork.



Easy to install with SB1-D



Soft Tail for Safety



Front Mudguard



Front Mudguard



64F2
Fixed Clamp

- Fit $\phi 25 \sim 32\text{mm}$ seat-post.



64H2
Quick-release "Strape" Clamp

- Fit $\phi 25 \sim 38\text{mm}$ seat-post.



64H3
Quick-release "Adjustable" Clamp with Plastic Screw

- Fit $\phi 25 \sim 38\text{mm}$ seat-post.



SB5-01
Exclusive Hardware

- Click fix on the BOTTOM of inner head tube.
- Fit $\phi 18.5 \sim 22.2\text{mm}$ / $\phi 22.2 \sim 25.4\text{mm}$ / $\phi 31.8 \sim 34.5\text{mm}$.



64H5
Quick-release "Strape" Clamp

- Fit $\phi 25 \sim 38\text{mm}$ seat-post.

SB1-D Exclusive Hardware

- Click fix on the BOTTOM of inner head tube.

Use Head tube(mm)				
$\phi 22.2$	•			
$\phi 25.4$	•	•		
$\phi 28.6$	•		•	
$\phi 31.8$	•			•
$\phi 34.5$	•	•		•

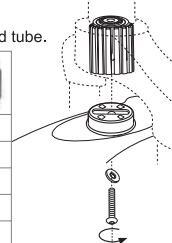

SW-FI-137 Series Quick-release Mudguard

• Material: PP



Fixation Type



Pre-bolted



Rubber Tie



FI-137-1
Carbon Sticker (PP)



FI-137-2
Double-Injection (PP / TPR)



FI-137-3
Double-Injection with Logo (PP / TPR)

SW-FI-151F/R Mudguard

- Material: PP
- Fit uni-crown fork Cantilever brake style.
- Fit $\varnothing 28.6 \sim \varnothing 31.8$ mm seat-tube.
- Slide in and fix.
- 4 position adjustable.



Seat-tube Clamp



Front Mudguard



Rear Mudguard



60mm



804N

Easy installation
Polyester nameplate
Fit $\varnothing 4$ mm fender stay.



SW-FI-117F/R Mudguard

- Material: PP
- Length adjustable up to 25mm.
- 2 sizes of clamps included for $\varnothing 28\sim 32$ mm & $\varnothing 32\sim 36$ mm seat-tubes.



Length Adjustable +25mm



Seat-tube Clamp



Front Mudguard



Rear Mudguard



66mm



SW-FI-133F/R Quick-release Mudguard

- Material: PC
- Available color: Black / Smoky / White.



Easy to install with SB1-D



Front Mudguard



Easy to install with 64H3-A



with Carbon Sticker



Mudguard Angle Adjustable



Bridge Angle Adjustable



SB1-D Exclusive Hardware

- Click fix on the BOTTOM of inner head tube.

Use Head tube(mm)	SB1-D	SB1-D	SB1-D	SB1-D
$\varnothing 22.2$	•			
$\varnothing 25.4$	•	•		
$\varnothing 28.6$	•		•	
$\varnothing 31.8$	•			•
$\varnothing 34.5$	•	•		•

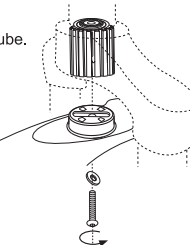

SB5-01 Exclusive Hardware

- Click fix on the BOTTOM of inner head tube.
- Fit $\varnothing 18.5 \sim 22.2$ mm $\varnothing 22.2 \sim 25.4$ mm / $\varnothing 31.8 \sim 34.5$ mm.

SW-FI-177F/R Mudguard

- Material: PP
- Fit uni-crown fork Cantilever brake style.
- Fit $\varnothing 28.6 \sim \varnothing 31.8$ mm seat-tube.
- Slide in and fix.
- 4 position adjustable.



Seat-tube Clamp



Front Mudguard



Rear Mudguard



SW-FI-151F/RL Mudguard

- Material: PP / TPR
- Fit uni-crown fork Cantilever brake style.
- Fit $\varnothing 28.6 \sim \varnothing 31.8$ mm seat-tube.
- Slide in and fix.
- 4 position adjustable.



Seat-tube Clamp



Front Mudguard



Rear Mudguard



SW-FI-153F/R Quick-release Mudguard

- Material: PP+TPR
- Special soft material to provide better safety
- Front-mudguard fit up to $\varnothing 34.5$ mm inner Head-tube
- Rear-mudguard fit up to $\varnothing 32$ mm Seat-post
- **FI-153F**: L 500 x W 75 x H 85 mm / 65g.
- **FI-153R**: L 550 (590 extended) x W 90 x H 120 mm / 185g.



Easy to install with SB1-D



Front Mudguard



Tool-free Rear Clamp



Angle Adjustable



Bridge Length Adjustable
Four adjusting points



Customizable Logo Plate



SB1-D Exclusive Hardware

- Click fix on the BOTTOM of inner head tube.

Use Head tube(mm)	SB1-D	SB5-01	SB5-02	SB5-03
$\varnothing 22.2$	•			
$\varnothing 25.4$	•	•		
$\varnothing 28.6$	•		•	
$\varnothing 31.8$	•			•
$\varnothing 34.5$	•	•		•



SW-FI-159 Mudguard

- Material: PP / TPR
- Soft TPR material to fit different shape of down-tubes.
- For aggressive ride.



Pre-bolted

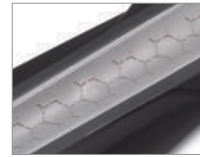

Anti-slip design

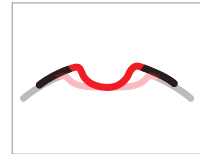

Elastic material to fit all tubes



SW-FI-173 F/R Mudguard

- Material: PP
- Fit 650B~29" Mountain-bikes.
- Slide in and fix.



Seat-tube Clamp



Front Mudguard



Rear Mudguard



Slide-fix Hanger
FI-171R / FI-171F



OPTIONAL
POP OFF5

**SAFETY QR FASTENER
INJECTED FENDER ONLY**
Safety design to detach in accident
and prevent jamming the wheel.

804N
Easy installation
Polyester nameplate
Fit ø4mm fender stay.



SW-FI-155F/R-A Quick-release Mudguard

- Material: PP
- Quick-release design on front mudguard to fit ø18.5 ~ 34.5mm Inner Head-tube.
- Length adjustable, 3-position rear bridge to fit up to 29" wheel.
(30mm adjusting range, 15mm for each position)
- Best coverage for maximum mud stop effect.



Front Mudguard



Easy to install with SB1-D1



Angle Adjustable



Slip-proof Strap Clamp



3-Position Adjustment



30mm 3-Step Adjustment



Packaged Size:
L 670 x W 114mm.

SW-FI-155F/R-B Quick-release Mudguard

- Material: PP
- Quick-release design on front mudguard to fit ø18.5 ~ 34.5mm Inner Head-tube.
- Length adjustable, twist-knob rear bridge to fit up to 29" wheel.
(40mm free adjusting range)
- Best coverage for maximum mud stop effect.



Front Mudguard



Easy to install with SB1-D1



Angle Adjustable



Slip-proof Strap Clamp



Twist-knob Adjustment



40mm Free Adjustment



Packaged Size:
L 660 x W 114mm.

SW-FX-119D Quick-release Mudguard (Down-tube)

- Material: PP
- Fits most down-tubes.
- Mudguard graphic can be easily custom-designed.
- L 368 x W 112 x H 60 mm. / Weight: 70 g.

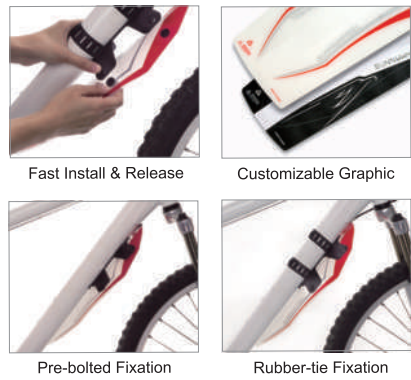

Packaged Size:
L 470 x W 190 x H 35 mm.

SW-FX-119R Quick-release Mudguard (Rear)

- Material: PP
- Fits up to Ø 32.5 mm seatposts.
- Angle adjustable.
- Mudguard graphic can be easily custom-designed.
- L 560 x W 114 x H 97 mm. / Weight: 200 g.



Packaged Size:
L 550 x W 190 x H 50 mm.

SW-FI-175F/R Mudguard

- Material: PP

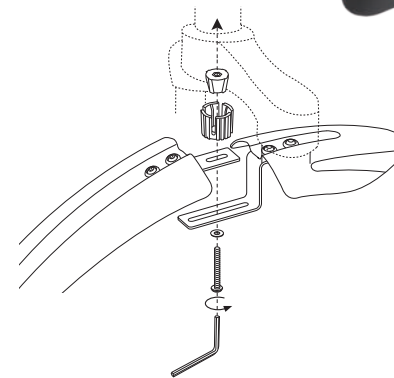
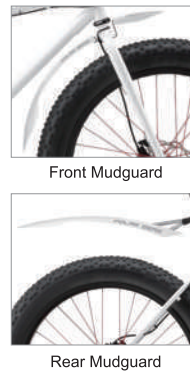

SW-FI-175D/R Down-tube Mudguard (For Snow-bike)

- Material: PP
- Rubber Tie to fit all sizes of down tubes.
- Quick and easy setup.
- Lightweight and durable.



SW-FX-119DC

Quick-release Mudguard (Down-tube)

- Material: PP
- Fits most down-tubes.
- Tool-free assembly for easier and faster installation.
- Innovative "One-piece-made" package design.
- Customizable graphic and die-cut.
- L 420 x W 140 x H 70 mm. / 93g.



Fast Install & Release



Rubber-tie Fixation



Integrated Package Design



Packaged Size:
L 585 x W 200 x H 35 mm.

SW-FX-119RC

Quick-release Mudguard

- Material: PP
- Fits up to ø32.5mm seatposts.
- Angle adjustable.
- Tool-free assembly for easier and faster installation.
- Innovative "One-piece-made" package design.
- Customizable graphic and die-cut.
- Fit 24~26" wheels.
- L 614 x W 78 x H 142 mm. / 155.5g.



Tool-free Assembly



Easy to Install with 64H3



Easy Install & Release



Angle Adjustable



Integrated Package Design



Packaged Size:
L 710 x W 200 x H 35 mm.

SW-FX-119DS

Quick-release Mudguard (Down-tube)

- Material: PP
- Fits most down-tubes.
- Tool-free assembly for easier and faster installation.
- Innovative "One-piece-made" package design.
- Customizable graphic and die-cut.
- L 400 x W 120 x H 55 mm. / 80g.



Fast Install & Release



Rubber-tie Fixation



Pre-bolted Fixation



Integrated Package Design



Packaged Size:
L 565 x W 200 x H 35 mm.

SW-FX-119RS

Quick-release Mudguard

- Material: PP
- Fits up to ø32.5mm seatposts.
- Angle adjustable.
- Tool-free assembly for easier and faster installation.
- Innovative "One-piece-made" package design.
- Customizable graphic and die-cut.
- Fit 26~29" wheels.
- L 573 x W 109 x H 90 mm. / 200g.



Tool-free Assembly



Easy to Install with 64H3



Easy Install & Release



Angle Adjustable



Integrated Package Design



Packaged Size:
L 638 x W 200 x H 35 mm.

SW-FI-111F/R Mudguard

- Material: PP
- Length adjustable up to 25mm.
- 2 sizes of clamps included for $\varnothing 28\sim 32\text{mm}$ & $\varnothing 32\sim 36\text{mm}$ seat-tubes.



Length Adjustable +25mm



Seat-tube Clamp



Front Mudguard



Rear Mudguard



OPTIONAL

POP OFF5

SAFETY QR FASTENER INJECTED FENDER ONLY

Safety design to detach in accident and prevent jamming the wheel.

SW-FI-171 F/R Mudguard

- Material: PP
- Fit 650B~29" City-bikes.
- Slide in and fix.
- Cable-friendly Clip to fit $\varnothing 28.6 \sim 31.8\text{mm}$ seat tube.



Seat-tube Clamp



Front Mudguard



Rear Mudguard



OPTIONAL

POP OFF5

SAFETY QR FASTENER INJECTED FENDER ONLY

Safety design to detach in accident and prevent jamming the wheel.

804N **TOOL FREE**

Easy installation

Polyester nameplate

Fit $\varnothing 4\text{mm}$ fender stay.

SW-668F/R Mudguard

- Material: PP
- Fit uni-crown fork Cantilever & V-brake.
- Fit $\varnothing 28.6 \sim \varnothing 31.8\text{mm}$ seat-tube.
- Fit 5/8" or 1/2" seat-stay bridge.
- Cable-friendly Clip to fit $\varnothing 28.6 \sim 31.8\text{mm}$ seat tube.



Front Mudguard



Rear Mudguard



OPTIONAL

POP OFF5

SAFETY QR FASTENER INJECTED FENDER ONLY

Safety design to detach in accident and prevent jamming the wheel.

SW-664F/R Mudguard

- Material: PP



Front Mudguard



Rear Mudguard



SW-CF-065F/R Mudguard

- Material: PP
- Front mudguard fits kid's bikes with suspension fork, v-brake and uni-crown fork.
- Slide-fix front mudguard hanger for easy installation & positioning.
- Mudguard hanger bendable for angle-adjusting.



Front Mudguard



Rear Mudguard



SW-647FS Mudguard

- Material: PP
- Fit kid's bike with uni-crown.
- Slide-fix mudguard hanger for easy installation & positioning.
- Mudguard hanger bendable for angle-adjusting.



Slide-fix Hanger



SW-FI-115F(FH)/R Quick-release Mudguard

- Material: PP
- Trendy & stylish.
- Multi-style selection.
- Effective mud stop.
- Easy installation.
- Tough and durable.
- Optional FI-115FH front mudguard with forehead.



Optional Alloy Strap



Optional Reflective Strap



Rear Mudguard



Front Mudguard



Optional Alloy / 3M Reflective Strap



SW-FI-115FH (with forehead)

SW-PS3F/PS1R Refoldable Quick-release Mudguard

- Material: PA6



"Clip-in" Front Mudguard

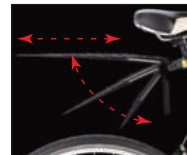

Adjustable Rear Mudguard



Safety Reflective Stickers

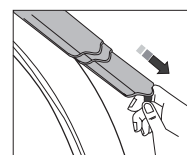

Refoldable Design

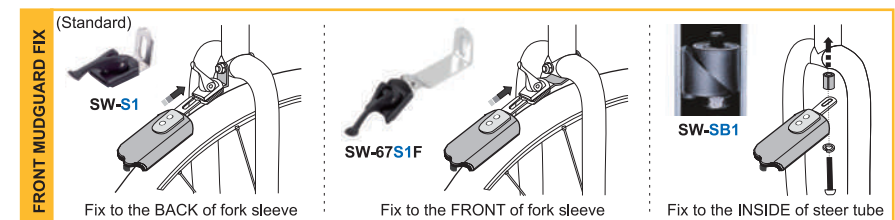

FRONT MUDGUARD FIX

(Standard) SW-S1 Fix to the BACK of fork sleeve

SW-67S1F Fix to the FRONT of fork sleeve

SW-SB1 Fix to the INSIDE of steer tube

SW-FI-179A Mudguard

- Material: PP
- Finish: Etched
- Fit for ROCK SHOX front fork, [MY21_SLD_35](#).
- Easy installation & positioning by fastened on front fork.

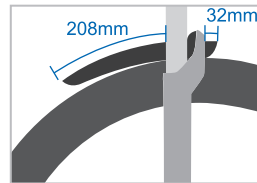
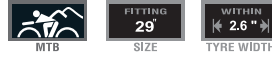

SW-FI-179B Mudguard

- Material: PP
- Finish: Etched
- Fit for ROCK SHOX front fork, [MY21_SLD_35](#).
- Easy installation & positioning by fastened on front fork.

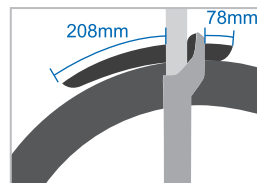

SW-650F/R Mudguard

- Material: PP
- Fit kid's bikes with uni-crown and cantilever or caliper brake style.
- Slide-fix mudguard hanger for easy installation & positioning.
- Mudguard hanger bendable for angle-adjusting.



Slide-fix Hanger



SW-651FS/RS Mudguard

- Material: PP
- Front mudguard fits kid's bikes with uni-crown fork.
- Various ED steel hardware of rear mudguard to meet different fitting needs.



Front Mudguard



Rear Mudguard



SW-651 REAR MUDGUARD HARDWARE

• Material: ED Steel

 <p>Standard</p> <ul style="list-style-type: none"> • Fit rear cantilever brake. • Mount bridge or bridge-plate. • Fit ATB recommended. 	 <p>SW-651-V1</p> <ul style="list-style-type: none"> • Fit rear cantilever / long arm V-brake. • Mount bridge or bridge-plate. 	 <p>SW-651-V3 / 659</p> <ul style="list-style-type: none"> • Fit rear V-brake. • Mount bridge or bridge-plate. 	 <p>SW-651-D1</p> <ul style="list-style-type: none"> • Fit rear drum brake. • Mount bridge or bridge-plate. 	 <p>SW-651-L1</p> <ul style="list-style-type: none"> • Fit side lock bikes only. • Mount bridge or bridge-plate.
--	--	--	---	--

SW-FI-179C Mudguard

- Material: PP
- Finish: Etched
- Fit for ROCK SHOX front fork:

SW-FI-179C:
[MY21_ZEB_38.](#)

SW-FI-179C1:
[MY21_35_35.](#)
[MY21_Recon_32.](#)

- Easy installation & positioning by fastened on front fork.

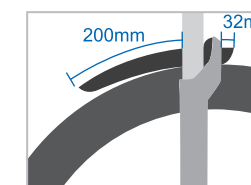

SW-FI-179D Mudguard

- Material: PP
- Finish: Etched
- Fit for ROCK SHOX front fork:

SW-FI-179D:
[MY21_ZEB_38.](#)

SW-FI-179D1:
[MY21_35_35.](#)
[MY21_Recon_32.](#)

- Easy installation & positioning by fastened on front fork.

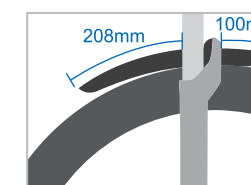

SW-71A(C/D3/E/F/H) Chainguard Bracket

• Material: ED Steel
SW-71A/E/F: fit inner BB $\phi 35\text{mm}$ / outer BB $\phi 40\text{--}45\text{mm}$ / BC 1.37" x 24 T.P.I.
SW-71C: fit $\phi 35\text{mm}$ BB only.



BRACKET & CHAINCOVER SYNOPSIS

SINGLE SPEED

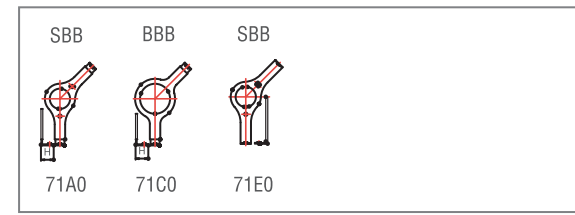

MODEL NUMBER	Available bracket
SW-CG-131	71A0
SW-768	71C0, 71E0
SW-771	
SW-772	
SW-773	71A0, 71C0
SW-777	
SW-780	
SW-780C	71A1, 71C0
SW-7802	
SW-788	71E1 clamp ($\phi 25.4$, $\phi 28.6$, $\phi 31.8$, $\phi 35$, $\phi 38.1$)

SBB	CHAIN CASE	Available bracket
71E0	SW-775	71E0
	SW-775S1-S3	

SHIMANO	BAFANG	BOSCH

TRIPLE SPEED



MODEL NUMBER	Available bracket
SW-761	71D3
SW-7714	71A3
SW-7724	71A3
SW-7734	71A3
SW-799	71A1

CHILD BIKE

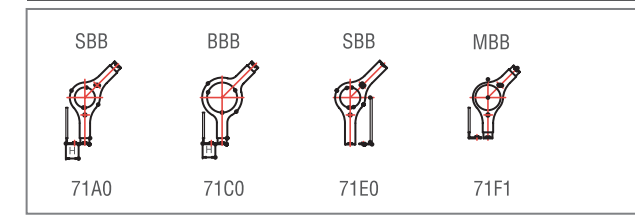

CHILD BIKE	Available bracket
SW-792	71A0, 71C0
SW-76001-03	
SW-760S1-S3	60SS, 60SM, 60SL
SW-760M1-M3	
SW-760L1-L3	60LS, 60LM, 60LL

E-BIKE (SHIMANO) E-BIKE (BAFANG) E-BIKE (BOSCH)

E-BIKE (SHIMANO)			E-BIKE (BAFANG)			E-BIKE (BOSCH)			
Type	Chain Case	Bracket	Type	Chain Case	Bracket	Type	Chain Case	Bracket	
DU-E5000 DU-E6100	SW-CG-173A	71K6	MM G360.250 M300	SW-CG-173A SW-CG-173A1	7110	Active Line Active Line Plus (Gen3)	SW-CG-173A	71J0	
	SW-CG-117	CG-117C					SW-CG-173B	71J1	
	SW-CG-139	71H2-05					SW-CG-113	71J2	
DU-E6001 DU-E6010 DU-E6050	SW-CG-173A SW-CG-173A1	71K2		SW-CG-173B	7111		SW-7802	71J3	
	SW-CG-173B	71K4		SW-CG-113	7112		SW-CG-117	71J4	
	SW-CG-139	71H0-03					SW-7802	7113	SW-CG-173A SW-CG-173A1
SW-CG-113	71H0-01	SW-CG-173B				71H1-02			
DU-E7000 DU-E8000	SW-CG-173A SW-CG-173A1	71K3		SW-CG-117	7114	Performance Line speed (Gen4)	SW-CG-139	71H1-05	
	SW-CG-173B	71K5					SW-CG-113	71H1-03	
	SW-CG-117	71K1					SW-7802	71H1-04	
EP8	SW-CG-173A SW-CG-173A1	71K3-1		MM G330.250 M410	SW-CG-117		7114-1		

SW-760 Chain Guard

- Material: (Standard)ABS or PC
- Finish: Gloss
- Different sizes of front and rear chainguard offer bikers more choices.
- The SW-760 full-chaingurd series provide you suitable sizes as your requirement.



12"		Final item No.: 76001 Teeth: 28T R.C. Range: 240~265mm	Final item No.: 760S1 Teeth: 28T R.C. Range: 215~240mm	Final item No.: 760M1 Teeth: 32~36T R.C. Range: 270~295mm	Final item No.: 760L1 Teeth: 32~36T R.C. Range: 300~325mm
14"~16"		Final item No.: 76002 Teeth: 28T R.C. Range: 275~300mm	Final item No.: 760S2 Teeth: 28T R.C. Range: 250~275mm	Final item No.: 760M2 Teeth: 32~36T R.C. Range: 305~330mm	Final item No.: 760L2 Teeth: 32~36T R.C. Range: 335~360mm
18"		Final item No.: 76003 Teeth: 28T R.C. Range: 300~325mm	Final item No.: 760S3 Teeth: 28T R.C. Range: 275~300mm	Final item No.: 760M3 Teeth: 32~36T R.C. Range: 330~355mm	Final item No.: 760L3 Teeth: 32~36T R.C. Range: 360~385mm
20"		Final item No.: 760X Teeth: 32~36T R.C. Range: 390~420mm			



PR-111 Chainguard Fork Protector



- S** Fit inner chainguard of B.B. size $\phi 35$ mm or B.C. 1.37"x24T.P.I.
- M** Fit inner chainguard of B.B. size $\phi 43.5$ mm
- L** Fit inner chainguard of B.B. size $\phi 51.5$ mm

- Prevent children from touching the rear chain.
- Decrease gap between the forks to the ISO 8098 4.15 safety standard.

SPECIFICATION LIST OF SW-760 SERIES

MODEL	TEETH	INNER DIAMETER OF CHAIN GUARD	R.C. RANGE	SUITABLE INNER CHAIN GUARD MODEL NUMBER						REMARK
				60SS	60SM	60SL	60LS	60LM	60LL	
SW-760S1	28T	$\phi 90$	215~240mm							
SW-760S2			250~275mm							
SW-760S3			275~300mm							
SW-76001			240~265mm	•	•	•				
SW-76002			275~300mm							
SW-76003			300~325mm							
SW-760L1	32T~36T	$\phi 90$	300~325mm							
SW-760L2			335~360mm							
SW-760L3			360~385mm							
SW-760M1			270~295mm				•	•	•	
SW-760M2			305~330mm							
SW-760M3			330~355mm							
SW-760X	32T~36T		390~420mm							

SW-719 Chain Cover

- Material: PC
- Finish: Gloss
- Fit models with crank/chain wheel distance between 6~16mm.



WITHIN $\langle 42-44T \rangle$ TEETH

STANDARD

15mm 11mm

OPTIONAL

70F
For non-threaded BB

SW-722(A) Chain Cover

- Material: PC
- Finish: Gloss
- BCD:104mm

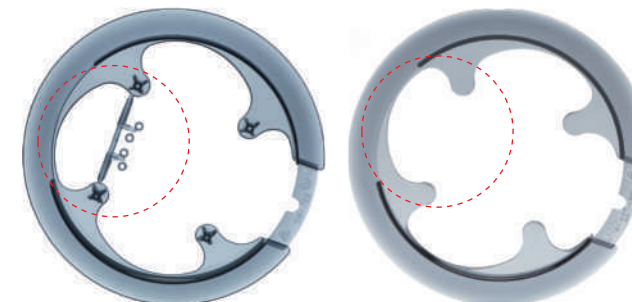

SW-722

SW-722A

WITHIN $\langle 42-44T \rangle$ TEETH

SW-720 Chain Cover

- Material: PC
- Finish: Gloss
- Fit models with crank/chain wheel distance between 6~16mm.



WITHIN $\langle 46-48T \rangle$ TEETH

STANDARD

15mm 11mm

OPTIONAL

70F
For non-threaded BB

SW-780 Chain Guard

- Material: PC
- Finish: Gloss



780 INNER DIAMETER SPEC.

MODEL	MIDDLE HOLE DIAMETER	REMARKS
SW-780	ø120mm	
SW-7801	ø80mm	
SW-7802	ø102mm	
SW-7803	ø112mm	
SW-780C	ø80mm	with colorful pad ring to make the whole bike vivid.

SW-780A Chain Guard

- Material: PC
- Finish: Matt (Etched)



780 INNER DIAMETER SPEC.

MODEL	MIDDLE HOLE DIAMETER
SW-780A	ø120mm
SW-7802A	ø102mm

SW-CG-139 Chain Guard

- Material: PC / ABS
- Finish: Gloss
- Designed with an auxiliary reflector for extra safety.



SW-CG-117 Chain Guard

- Material: PC
- Finish: Gloss



SW-CG-173A1 Chain Guard

- Material: PC
- Finish: Gloss



CHAIN GUARD

SW-792 Chain Guard

- Material: ABS
- Finish: Gloss
- Fit 20" rear end with extended mounting hole.



CHAIN GUARD

SW-CG-173A Chain Guard

- Material: PC
- Finish: Gloss



SW-CG-113 Chain Guard

- Material: PC
- Finish: Gloss
- Color customizable window plate.



SW-771(7714) Chain Guard

- Material: PC
- Finish: Gloss



SW-CG-133 Chain Guard

- Material: PC
- Finish: Gloss



INNER DIAMETER SPEC.

MODEL	MIDDLE HOLE DIAMETER
CG-1331	ø80mm
CG-1332	ø102mm
CG-1333	ø112mm
CG-1334	ø120mm

SW-CG-173B Chain Guard

- Material: PC
- Finish: Gloss

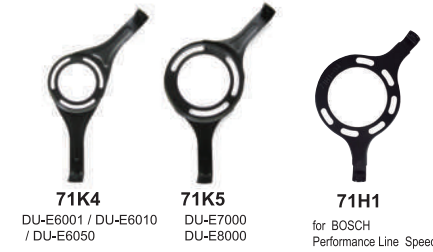

SW-773(7732) Chain Guard

- Material: PC
 - Finish: Gloss
- SW-773: Inner ø155mm.
SW-7732: Inner ø102mm.



SW-799 Chain Guard

- Material: PC
- Finish: Gloss
- Innr Diameter Choice: ϕ 130mm / ϕ 170mm / ϕ 190mm / ϕ 212mm.



SW-CG-133A Chain Guard

- Material: PC
- Finish: Etched



INNER DIAMETER SPEC.

MODEL	MIDDLE HOLE DIAMETER
CG-1331A	ϕ 80mm
CG-1332A	ϕ 102mm
CG-1333A	ϕ 112mm
CG-1334A	ϕ 120mm

SW-CG-131 Chain Guard

- Material: PC
- Finish: Gloss
- Weight: 164g



Streamline Look on Bike



SW-CG-153 Chain Guard

- Material: Aluminum
- Finish: Coated / Anodized



Customizable Service



71H3
M333.250
(M410)



SW-772(7724) Chain Guard

- Material: PC
- Finish: Gloss
- SW-772: Inner ϕ 150mm / Max. Crank Fit: 50T.
- SW-7724: Max. Crank Fit: 48T.



SW-7724

SW-777 Chain Guard

- Material: PC
- Finish: Gloss



SW-761 Chain Guard

- Material: PC
- Finish: Gloss



SW-CG-135 Chain Guard

- Material: PC
- Stylish look on BOSCH SYSTEM .



Bracket For CG-135
Material: SUS 304



M5*10mm M5*18mm

SW-CX-111A Universal Aluminum Chain Guard

- Material: Aluminum / PC
- Designed for Road-bike (52T) and MTB (44T).
- Universal strap to fit all sizes/shapes of Down-tubes and Seat-stays.
- L 515~585 x W 160 x H 40 mm / Weight: 180g.
- Finish: Ano Silver w / sandblast



Stylish Look



Universal Down-tube Strap



Universal Seat-stay Strap

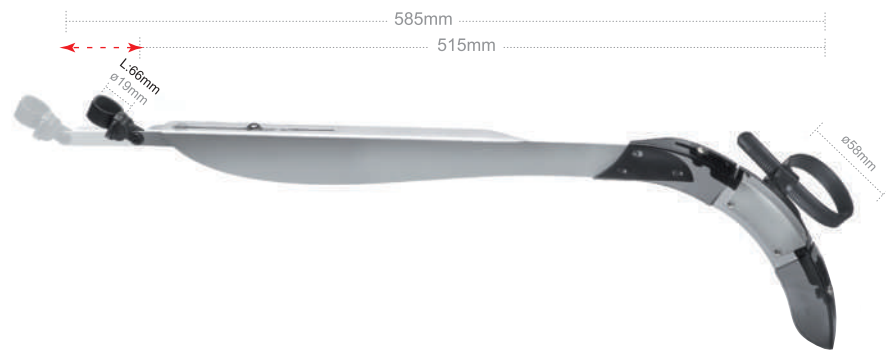

MTB 44T Road 52T
Universal Brackets

SW-CF-513 Aluminum Chain Guard

- Material: Aluminum
- Finish: Ano Matt BK



CF-513
BB Bracket



70C Seat Stay Clamp

- 70C1 ø1/2" (12.7mm)
- 70C2 ø5/8" (15.8mm)
- 70C3 ø3/4" (19mm)
- 70C4 ø7/8" (22mm)

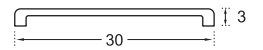

SW-CG-151 Chain Guard

- Material: PC / ABS
- Finish: Gloss
- Stylish look on bike.



Decorative Reflector



Decorative Reflector

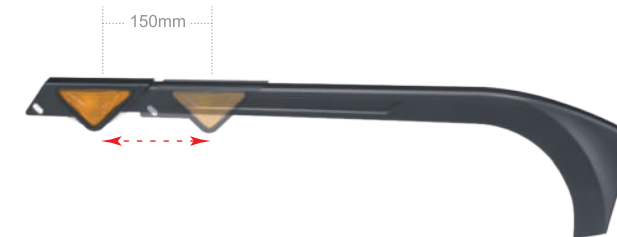

70C Seat Stay Clamp

- 70C1 ø1/2" (12.7mm)
- 70C2 ø5/8" (15.8mm)
- 70C3 ø3/4" (19mm)
- 70C4 ø7/8" (22mm)

788 CLAMPS

- Ø 25.4mm
- Ø 28.6mm
- Ø 31.8mm
- Ø 35mm
- Ø 38.1mm

SW-CG-171 SHIMANO motor top cover

- Material: PC
- Stylish look on SHIMANO.
- Finish: Coated Matt BK



Front Chain Guards



Rear Chain Guards



M4*10mm

SW-70A BB / Bracket Spacer

- Material: Aluminum
- Threaded ring to ensure BB clamp is well fixed to BB.
- Available Size: $\varnothing 35 \times 40 \times 1.5\text{mm}$.
- $\varnothing 35 \times 40 \times 2.64\text{mm}$.



SW-788 Series

- Material: PP
- Finish: Gloss
- Exclusive for BMX.



788 CLAMPS



$\varnothing 25.4\text{mm}$



$\varnothing 28.6\text{mm}$



$\varnothing 31.8\text{mm}$



$\varnothing 35\text{mm}$



$\varnothing 38.1\text{mm}$



SW-788

- Fit within 44T.
- Length: 330mm.



SW-788A

- Fit within 28~36T.
- Length: 330mm.



SW-788C

- Fit within 23~28T.
- Length: 335mm.



SW-788D

- Fit within 36~44T.
- Length: 450mm.



SW-788E

- Fit within 32~44T.
- Length: 406mm.

SW-70C Seat-stay Clamp

- Material: PA
- 70C1:** fit $\phi 1/2"$ (12.7mm)
- 70C2:** fit $\phi 5/8"$ (15.8mm)
- 70C3:** fit $\phi 3/4"$ (19mm)
- 70C4:** fit $\phi 7/8"$ (22mm)



SW-70G(G1/G2) Universal Seat-stay Strap

- Material: PA
- 70G1:** $\phi 12.7\text{mm} \sim \phi 25.4\text{mm}$
- 70G2:** $\phi 19\text{mm} \sim \phi 65\text{mm}$



Universal Seat-stay Strap



SW-70D(D1/D2/D3) Chain-stay Clamp

- Material: ED Steel
- Fit $\phi 1/2" \sim 7/8"$ chain stay.
- SW-70D:** for single or multi-speed chainguards.
- SW-70D1:** for multi-speed and SHIMANO Megarange freewheel chainguards.
- SW-70D2:** fit all tubes ($\phi 17 \sim \phi 23.2\text{mm}$).
- SW-70D3/D3-1~4:** Chain stay must have M5 screw hole.



SW-70D3 Series

SW-70D3 Series



SW-AP-111 Spoke Protector

- Material: ABS
- Prevents spokes from getting damaged.
- Not suitable for Campagnolo hubs.



For Cassette Freehub



130mm



SW-AP-115 Spoke Protector

- Material: ABS
- Prevents spokes from getting damaged.



For Threaded Hub



136.5mm



SW-AP-113 Spoke Protector

- Material: ABS
- Prevents spokes from getting damaged.
- Not suitable for Campagnolo hubs.



For Cassette Freehub



152mm



SW-AP-135 Spoke Protector

- Material: ABS
- Clip-mounted to prevent spokes from getting damaged.
- Not suitable for Campagnolo hubs.



For Spoke Fitting



162mm



SW-CE-111 Bicycle Clip-On Chain Cover

- Material: POM
- Fit 1/2" x 1/8" Single Speed Bike
- Easy clip on chain.
- This Bicycle clip-on chain cover can be installed on general type except quick release chain.



Customization Colour Available



Flexible On Chain



Packaged Size:
L 112 x W 37 x H 183mm,
Qty:120pcs per pack.

STANDARD COLOUR TABLE



SW-DG-115 Dress-guard

- Material: PC / PP (clip)
- Clip to fit 26" / 700C bikes.
- Light-weight with maximized protection.
- For All Plastic-made and FA-513 Aluminum Fender.



Max Protection



Seat-stay Brackets

L ø19~22.2mm

M ø15.8mm

S ø12.8mm



Packaged Size:
L 450 x W 25 x H 210mm.

SW-903 Front Basket

- Material: PP
- Suitable for 24" / 26" bikes.

weight
520
g



SW-909 Front Basket

- Material: PP
- Suitable for 26" / 700C bikes.
- Available with/without handle.

weight
730
g

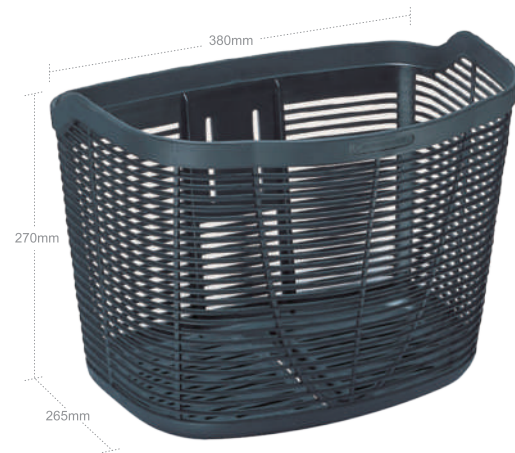

Optional Basket Handle

SW-507 Basket Bracket

Choosing the suitable basket bracket is also a quite important factor, which needs to be considered. Because of various bicycle frames with different angles and sizes on the market, multiple bracket styles from Sunny Wheel are not only with the advantage of easy installation, but it can also meet the customers' requirements on the beauty and style for whole bicycle.

SW-507
Basket back bracket
• Material: ED Steel



SW-507A
Basket bottom bracket
• Material: ED Steel



SW-507B
Fitting parts for basket back bracket
• Material: ED Steel



SW-507C
Fitting parts for basket bottom bracket
• Material: ED Steel



SW-507F
Plastic parts for basket bottom bracket.



SW-507G/H
Plastic parts for basket bottom bracket.

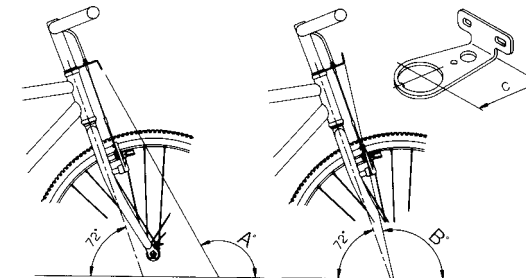

Basket back bracket for cantilever w. adjustable screw & nut set

MODEL	for stem ø25.4	for stem ø25.4 & w. Cantilever	for stem ø28.6	for stem ø28.6 & w. Cantilever	A°	B°	C
SW-507	•				118°	98°	75
SW-5071		•			110°	106°	56
SW-5072	•				96°	120°	121
SW-5073A	•						
SW-5073B		•					
SW-5073C			•		118°	98°	74
SW-5073D			•				
SW-5074A	•						
SW-5074B		•			123°	93°	97
SW-5074C			•				
SW-5074D			•				
SW-5075A	•				110°	106°	94
SW-5075B		•					
SW-5075C			•				
SW-5075D				•			
SW-5076A	•						
SW-5076B		•					
SW-5076C			•				
SW-5076D				•			

A: for ø25.4mm stem B: for ø25.4mm stem & w. cantilever C: for ø28.6mm stem D: for ø28.6mm stem & w. cantilever

SW-914-4 Front Basket

- Material: Steel / Vynil
- Suitable for 26" / 700C bikes.
- Easy-install and disassemble basket cover included.
- Basket cover included to prevent loads from falling out.
- Quick-release hardware available.
- Optional upgraded handle(BKG-11) to select.

weight
1000
g



Upgraded Handle (BKG-11)



SW-914-5 Front Basket

- Material: Steel / Vynil
- Suitable for 26" / 700C bikes.
- Easy-install and disassemble shopper bag included.
- Shopper bag included to prevent loads from falling out.
- Quick-release hardware available.

weight
940
g



Removable Shopper Bag

SW-912S(M) Front Basket

- Material: Hand-woven PP
- SW-912S:** for 12" / 16" Kid's bikes.
- SW-912M:** for 16" / 20" Kid's bikes.

weight
110
S

weight
150
M



SW-915 Front Basket

- Material: PP
- Suitable for 24" / 26" bikes.
- Available with/without handle.

weight
710
g

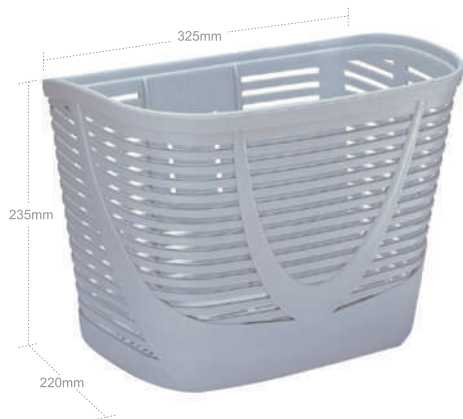

Optional Basket Handle

SW-914 Front Basket

- Material: Steel
- Suitable for 26" / 700C bikes.
- Standard handle included.
- Quick-release hardware available.
- Optional upgraded handle(BKG-11) to select.

weight
830
g



Upgraded Handle (BKG-11)

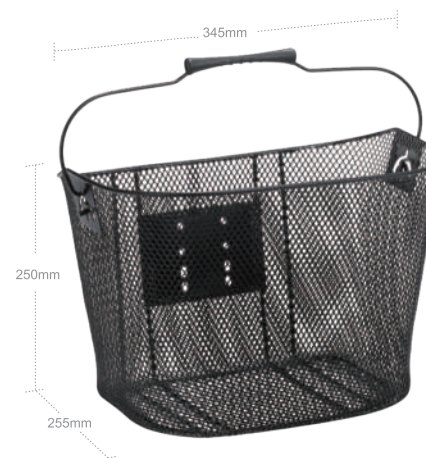

SW-914-3 Front Basket

- Material: Steel
- Suitable for 24" / 26" bikes.
- Standard handle included.
- Quick-release hardware available.
- Optional upgraded handle(BKG-11) to select.

weight
680
g



Upgraded Handle (BKG-11)



SW-920 Front Basket

- Material: PP
- Suitable for 24" / 26" bikes.
- With Panel.

weight
440
g



SW-920-2 Front Basket

- Material: PP
- Suitable for 24" / 26" bikes.
- Without Panel.

weight
460
g

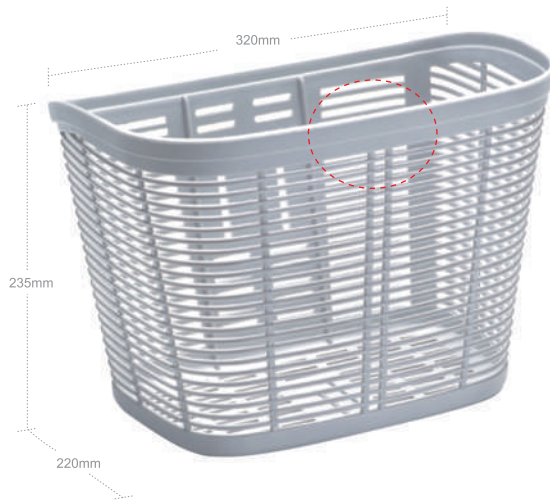

SW-KA-113 Front Basket (For Kid's Bike)

- Material: PP
- For 12" ~ 20" kids bikes.
- Bracket option: SW-5072 / SW-5072A / SW-507B / SW-507C.

weight
240
g



Lovable Look on Kid's Bike



Weave-like Injection



SW-KA-113A

COLOR CHOICE



White



Orange



Purple

SW-919 Front Basket

- Material: PP
- Suitable for 24" / 26" bikes.

weight
650
g



For SW-919 & SW-919-1



Suitable for Carrying Pets



Optional Basket Base

SW-919-1 Front Basket

- Material: PP
- Suitable for 24" / 26" bikes.
- To fit front reflector.

weight
630
g

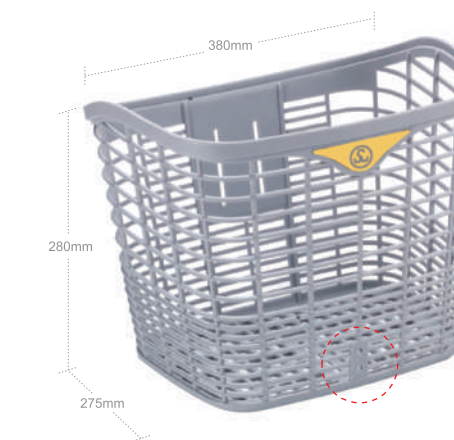

For SW-919 & SW-919-1

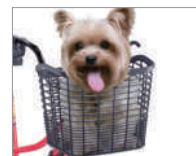

Suitable for Carrying Pets



Optional Basket Base

SW-KA-117R Rear Basket

- Material: PP
- Fix to rear carrier.



Max. Capacity: 27 L.



Woven-like Injection



Reflective Sticker

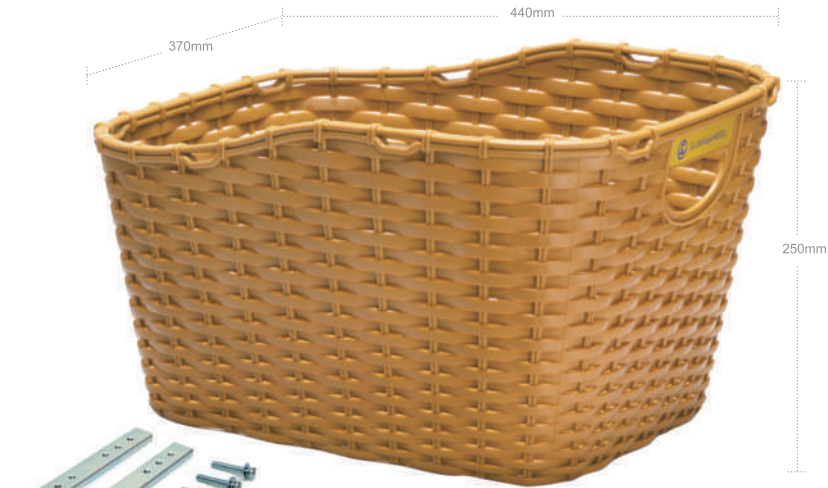

weight
1160
g



Optional Basket Lid

SW-KA-119 Front Basket

- Material: PP
- Fit 24"~26" City bikes



Suitable for City Bikes



Woven-like Injection



weight
730
g



Optional Basket Lid & Handle

COLOR CHOICE



Yellow



Light Brown



Black

SW-KA-115 Front Basket (For Kid's Bike)

- Material: PP
- Fit 16"~18" kid's bikes
- Colors customizable upon request



weight
300
g

KA-115
Duotone-Color Injection



Lovable Look on Kid's Bike



KA-115

SW-KA-115A Front Basket (For Kid's Bike)

- Material: PP
- Fit 16"~18" kid's bikes
- Colors customizable upon request



weight
300
g

KA-115A
Single-Color Injection



Lovable Look on Kid's Bike



KA-115A

SW-KA-117 Front Basket

- Material: PP
- Fit 24"~26" City bikes
- W 389 x D 297 x H 260 mm.



Suitable for City Bikes



Woven-like Injection



weight
700
g



Optional Basket Lid & Handle

COLOR CHOICE



Yellow



Light Brown



Dark Brown



Black

SW-KA-133 Front Basket

- Material: PP
- Suitable for 16" / 18" kid's bikes.
- Duo-woven texture.

weight
550
g

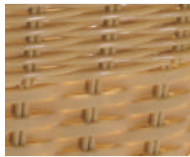

Duo-woven Injection

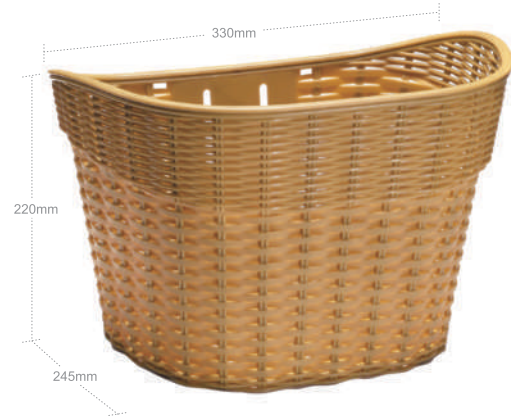

Optional Basket Lid

SW-KA-151 Front Basket

- Material: PP
- Suitable for 24" / 26" / 700C bikes.

weight
525
g

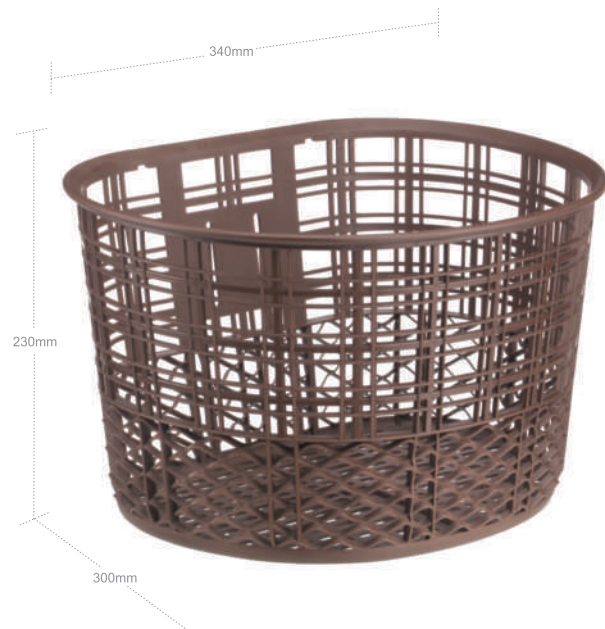

SW-KA-125 Front Basket

- Material: PP
- Suitable for 26" / 700C bikes.

weight
480
g



Woven-like Texture



Optional Basket Lid

SW-KA-131 Front Basket

- Material: PP
- Suitable for 24" / 26" city bikes.
- Extra-wide space for easier load of briefcase & school bags etc.
- * Exclusive distribution: Japan by BRIDGESTONE.

weight
740
g

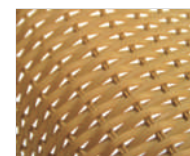

oven-like Injection

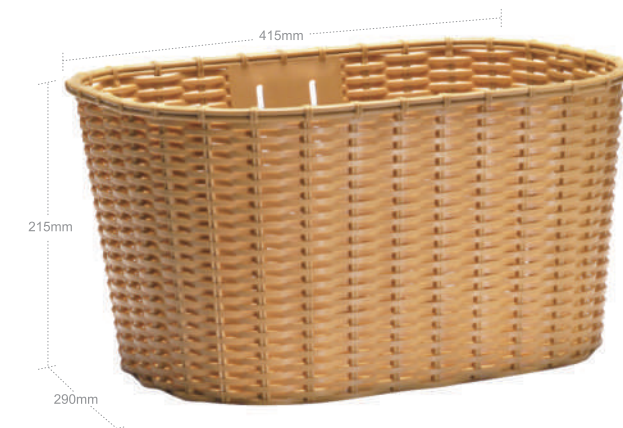

SW-CB-111 Rear-carrier Lockable Case

- Material: PP
- Capacity: 12 L.
- CR-111: Quick-release adaptor without lock.
- CR-111B: Quick-release adaptor with integrated lock on button.
- CR-113: Quick-release adaptor.



Lockable



Fast Attach & Remove



Portable



Spacious



CB-111 (Standard)



SW-NKC-004



CR-111
without Lock



CR-111B
Integrated-Lock on Button.



CR-113

SW-KC-113A/B Furkids joie

- Material: PP
- L 430 x W 290 x H 235 mm. / Weight: 1295g.
- Adapt Stay: SW-QR-113A / SW-QR-113B



Ergonomic design



Portable



Adapt Stay SW-QR-113A
SW-QR-113B



SW-KC-113A



SW-KC-113B



Colorful

SW-RBK-ST1 Rear Basket

- Material: PP
- Rear carrier fixation.
- * Exclusive distribution: Japan by BRIDGESTONE.

weight
1090
g



Maximized Capacity



COLOR CHOICE



Light Gray



Beige



Brown

SW-RBK-ST2 Rear Basket

- Material: S.T.P.P.
- Rear carrier fixation.
- * Exclusive distribution: Japan by BRIDGESTONE.

weight
1190
g



Maximized Capacity



COLOR CHOICE



Light Gray



Beige

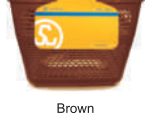

Brown

SW-906A Rear-carrier Lockable Case

- Material: PP
- Capacity: 13.5 L.
- With flat base.
- Colour: ● ●
- Customized colour available with MOQ:500 sets.



SW-NKC-003

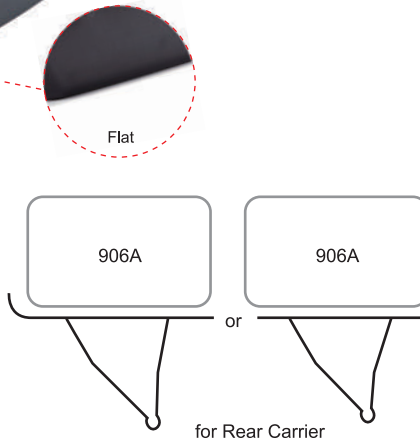

SW-DC01/M Doll Carrier

- Material: PP
- Conforms to CE saety regulation.
- Fixable to seat stay bridge(wih bracket-R) & fork(wih bracket-F) .

weight
200
g

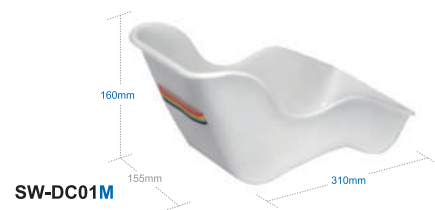

SW-DC01M



SW-NKC-001 Bracket-R
SW-NKC-002 Bracket-F

SW-KC-111 Rear-carrier Lockable Case

- Material: ABS
- Capacity: 12 L.
- Optional Laptop Holder available (Fit Laptop size: L 280~320 x W 200~250 mm.)
- L 485 x W 315 x H 190 mm. / Weight: 1.6 kg.
- Colour: ●
- Customized colour available with MOQ:500 sets.
- KC-111: Case only.
- KC-111A: Optional Laptop Holder only.
- KC-111-01: Case with Laptop Holder included.



Elastic Secure Net



Optional Laptop Holder



Reflective Sticker



Lockable



KC-111A Laptop Holder



SW-NKC-004



Fall-proof Lid



Large-capacity

SW-KC-115 Rear-carrier Lockable Case

- Material: Box / PCR-rPP Pad / EVA
- Capacity: 15 L.
- L 465 x W 333 x H 217mm
- 3M reflective sticker (Color : red / silver)
- Adapt with : SW-CR-111 / SW-CR-113 / MIK system
- Available for E-commute bike
- Colour: ●



Reflective Sticker



Lockable



Pad: L 369.5 x W 243mm



SW-NKC-003



CR-111
without Lock



CR-111B
Integrated-Lock on Button.



CR-113



MIK

SW-CH-117 Handlebar Mount for Bottle Holder

- Material: PA6
- Fix on handlebar to hold bottle cage.
- Angle adjustable.
- Fit $\varnothing 22.2 \sim \varnothing 35\text{mm}$ handlebars.
- * Bottle cage not included.



Packaged Size
L 145 x W 110mm.

SW-CH-117A Handlebar Mount

- Material: PA6
- Fit $\varnothing 22.2 \sim \varnothing 35\text{mm}$ handlebars.



Angle-adjustable



Packaged Size
L 145 x W 110mm.

SW-CH-117B Handlebar QR Mount for Bottle Holder

- Material: PA6
- Fit $\varnothing 22.2 \sim \varnothing 35\text{mm}$ handlebars.



Works on Handlebar



Quick-Release



Packaged Size
L 145 x W 110mm.

SW-CR-111/CR-111B Quick-release Adaptor

- **CR-111:** Quick-release adaptor without lock.
- Material: PP
- Adapt with: SW-KC-111 / SW-KC-115 / CB-111 / SW-906A
- **CR-111B:** Quick-release adaptor with integrated lock on button.
- Material: PP
- Adapt with: SW-KC-111 / SW-KC-115 / CB-111 / SW-906A



SW-CR-113 Quick-release Adaptor

- Material: PA+GF / PCR-PA+GF
- L 250 x W 160 x H 25mm / Weight : 680g
- Adapt with: SW-KC-115 / SW-KC-111 / CB-111 / SW-906A / SW-906
- Fit $\varnothing 8 \sim 16\text{mm}$ (shelf tube)
- Width: 70~160 mm / 130~200 mm



360°



Release unlock



GPS Trackers storage space



SW-QRB(1/3/5) Handlebar Quick-release Adaptor

- Material: PA6
- Multi-angle adjustable.
- Adapt all Sunny Wheel baskets and bags.
- German Patent #20300747.6

QRB: fit $\varnothing 22.2$ / $\varnothing 25.4$ mm handlebars.

QRB1: fit $\varnothing 25.4$ / $\varnothing 28.6$ / 31.8mm handlebars.

QRB3: fit $\varnothing 22.2$ / Tapered $\varnothing 22.2$ ~25.4mm handlebars.

QRB5: fit $\varnothing 22.2$ / $\varnothing 25.4$ / $\varnothing 28.6$ / $\varnothing 31.8$ mm / Tapered $\varnothing 22.2$ ~25.4mm handlebars.



Multi-angle Adjustable



SW-QRF2 Upright-post Quick-release Adaptor

- Material: PA6
- With Press release system.
- Fit $\varnothing 25$ ~32mm upright head tube or seat posts.
- Adapt all Sunny Wheel baskets and bags.

QRF2: Medium-length arm with adjustable angle.



QRF2

Medium-length Arm with Adjustable Angle

QRF2-1

fit $\varnothing 35$ ~ $\varnothing 38$ mm upright head tube or seat posts.



SW-QC-111A Saddle Rail Mount

- Material: Nylon / Aluminum



SW-QC-113A Saddle Rail QR Mount for Mudguard

- Material: Nylon / Aluminum



with PS1R Fender



SW-QC-115A Saddle Rail QR Mount for Bottle Holder

- Material: Nylon / Aluminum



Fits most Bottle Holder



SW-QA-111 series Aluminum Handlebar Quick-release Adaptor

- Material: Aluminum / PA6
- **QA-111E:** Fit $\phi 22.2 \sim 31.8$ mm handlebars / Compatible with SW-QRB5
- L 135 x W 54 x H 75 mm / Weight: 290g
- **QA-111E1:** Fit $\phi 22.2 \sim 31.8$ mm handlebars / Width: 75 mm (For E-bike)
- **QA-111E2:** Fit $\phi 22.2 \sim 31.8$ mm handlebars / Width: 95 mm (For E-bike)
- **QA-111E3:** Fit $\phi 22.2 \sim 31.8$ mm handlebars / Width: 120 mm (For E-bike)
- Color Choice: Sandblasted Silver / Sandblasted Black

Patented

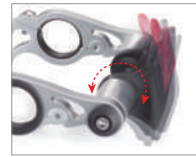

Angle-adjustable



Customizable Laser Logo



SHIMANO system



BOSCH system



QA-111E

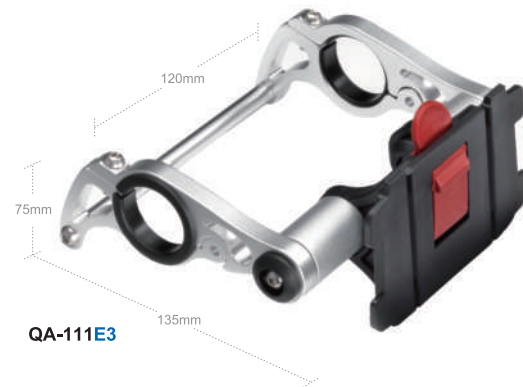

QA-111E3



QA-111E1



QA-111E2

SW-QRD

Upright-post Quick-release Adaptor

- Material: PA6
- Adapt all Sunny Wheel baskets and bags.
- Selective QR01(S) steel clamp to fix upright head tube or seat post.
- **QRD:** with Press release system.



QRD (Press button)

SW-QR01(S)

Upright-post Quick-release Adaptor Clamp

- Material: ED Steel
- Adapt with SW-QRD.
- **QR01:** fit $\phi 25.4 \sim 32$ mm upright head tube or seat post.
- **QR01S:** fit $\phi 22.2 \sim 25.4$ mm upright head tube or seat post.



Adapt with QRD

SW-QRE

Upright-post Quick-release Adaptor

- Material: PA6
- With Push-back release system.
- Fit $\phi 25 \sim 32$ mm upright head tube or seat posts.
- Adapt all Sunny Wheel baskets and bags.
- **QRE:** Short arm with fixed angle.

SW-QRE2

Upright-post Quick-release Adaptor

- Material: PA6
- With Push-back release system.
- Fit $\phi 25 \sim 32$ mm upright head tube or seat posts.
- Adapt all Sunny Wheel baskets and bags.
- **QRE2:** Medium-length arm with adjustable angle.

SW-QRE3 SW-QRE3-1

Upright-post Quick-release Adaptor

- Material: PA6
- With Push-back release system.
- **QRE3:** Fit $\phi 25 \sim 32$ mm upright head tube or seat posts.
- **QRE3-1:** Fit $\phi 35 \sim 38$ mm upright head tube or seat posts.
- Adapt all Sunny Wheel baskets and bags.
- **QRE3:** Longest arm with adjustable angle.
- **QRE3-1:** Longest arm with adjustable angle.



QRE Short Arm with Fixed angle

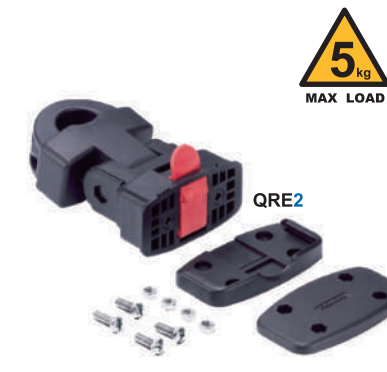

QRE2 Medium-length Arm with Adjustable Angle



QRE3 Longer Arm with Adjustable Angle

SW-QR-113A

Handlebar Quick-release Adaptor

Patented

- Material: PA6
- L 140 x W 60 x H 70 mm / Weight: 245g

•QR-113A: Fit $\varnothing 22.2 \sim 31.8$ mm handlebars / Width: 60 mm



Angle-adjustable



Quick-release for Basket



SW-QR-113B

Handlebar Quick-release Adaptor

- Material: PA6
- L150 x W 90 x H 95 mm / Weight: 272g

•QR-113B: Fit $\varnothing 22.2 \sim 31.8$ mm handlebars / Width: 90 mm (For E-bike)



Fit E-BIKE panel



Angle-adjustable



SW-QA-113 series

Aluminum Handlebar Quick-release Adaptor

Patented



- Material: Aluminum / PA6
- QA-113E: Fit $\varnothing 22.2 \sim 31.8$ mm handlebars / Compatible with SW-QRB5
- L 169 x W 54 x H 90 mm / Weight: 310g

- QA-113E1: Fit $\varnothing 22.2 \sim 31.8$ mm handlebars / Width: 75 mm (For E-bike)
- QA-113E2: Fit $\varnothing 22.2 \sim 31.8$ mm handlebars / Width: 95 mm (For E-bike)
- QA-113E3: Fit $\varnothing 22.2 \sim 31.8$ mm handlebars / Width: 120 mm (For E-bike)
- Color Choice: Sandblasted Silver / Sandblasted Black



Quick-release for Basket



Angle-adjustable



Customizable Laser Logo

QA-113E



QA-113E3



QA-113E1



QA-113E2



SW-GC-113 Bicycle Grip

- Material: TPR
- Length: 112mm
- Design for ø22.2mm handlebar
- Anit Slip

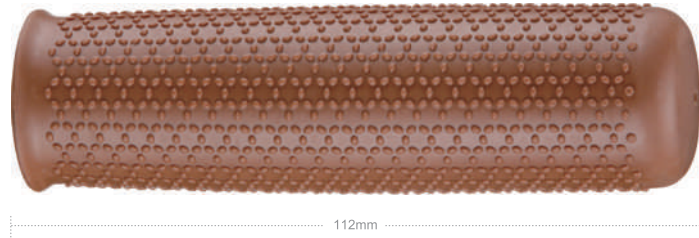

SW-GC-135 Bicycle Grip

- Material: TPR
- Length: 140mm
- Design for ø22.2mm handlebar



Shock-absorbent Design



SW-GC-117 Bicycle Grip

- Material: TPR / PP
- Horn-shape bar end for better safety.
- Length: 130mm
- Design for ø22.2mm handlebar



Shock-absorbent Design

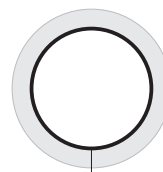

PP inner tube

SW-GC-151 Bicycle Grip

- Material: TPR
- Length: 102mm / 140mm
- Design for ø22.2mm handlebar



Shock-absorbent Design



SW-GC-171A Patented Bicycle Grip

- Material: TPR / PP
- Length: 138mm
- Design for ø22.2mm handlebar
- Duotone colour design

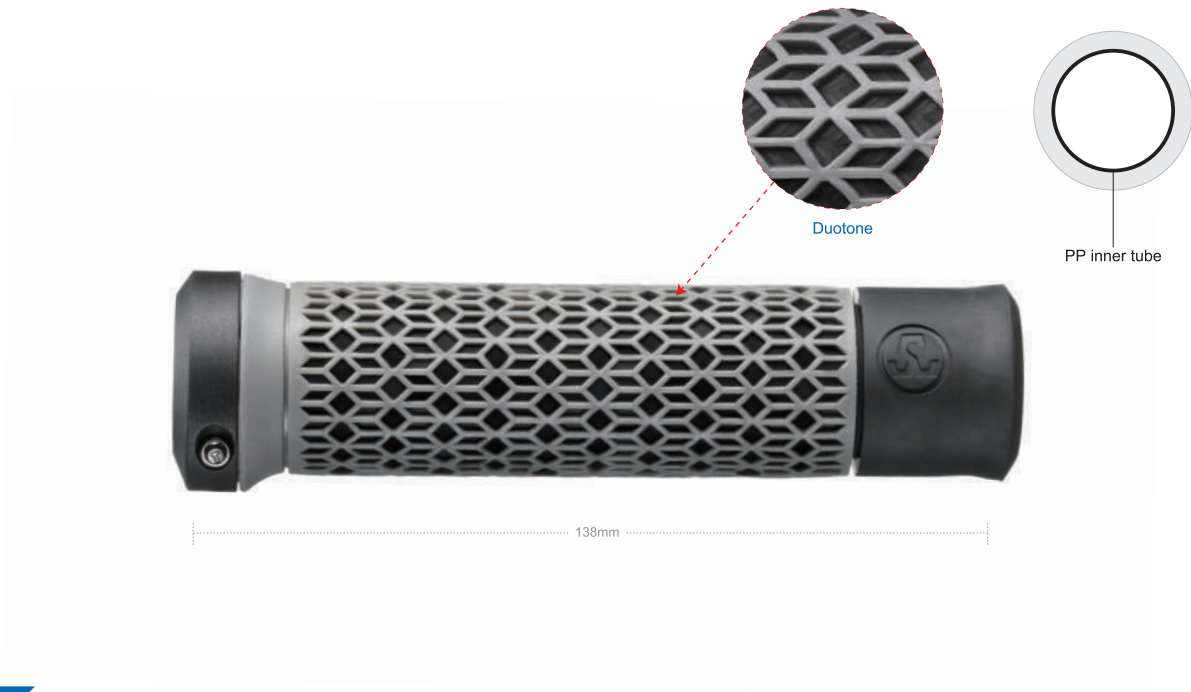

SW-GC-159A Patented Bicycle Grip

- Material: TPR / PP
- A clean and modern look.
- Length: 138mm
- Design for ø22.2mm handlebar
- Duotone colour design

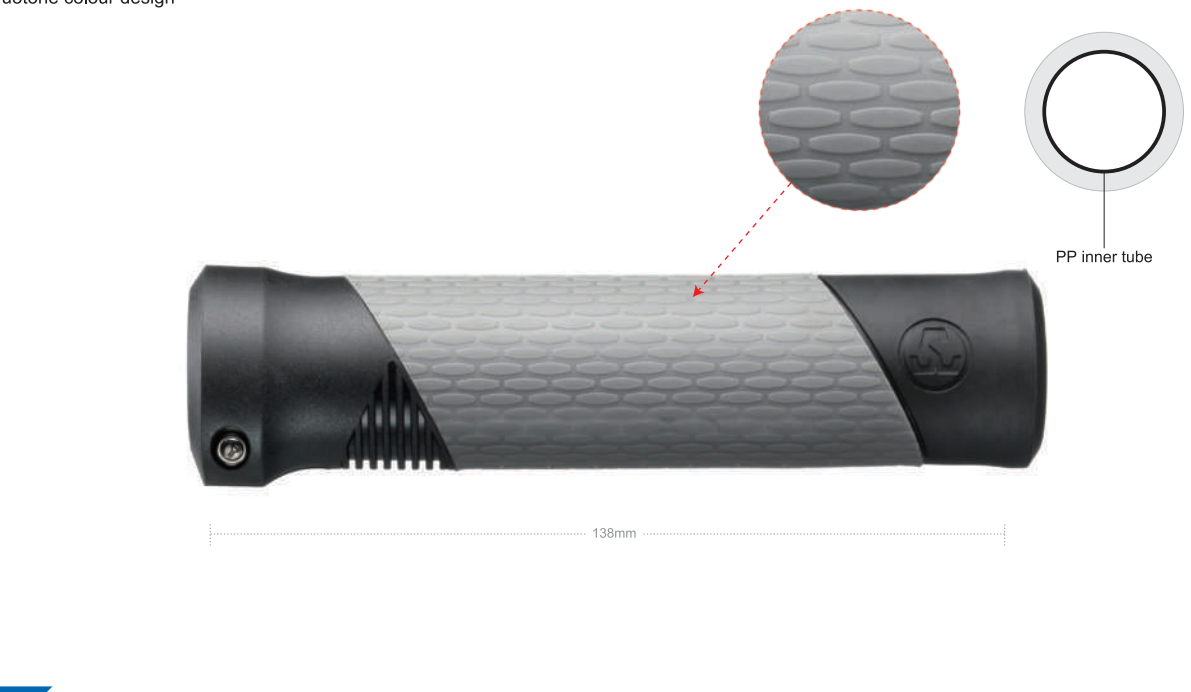

SW-GC-171B Patented Bicycle Grip

- Material: TPR
- Length: 138mm
- Design for ø22.2mm handlebar
- Duotone colour design

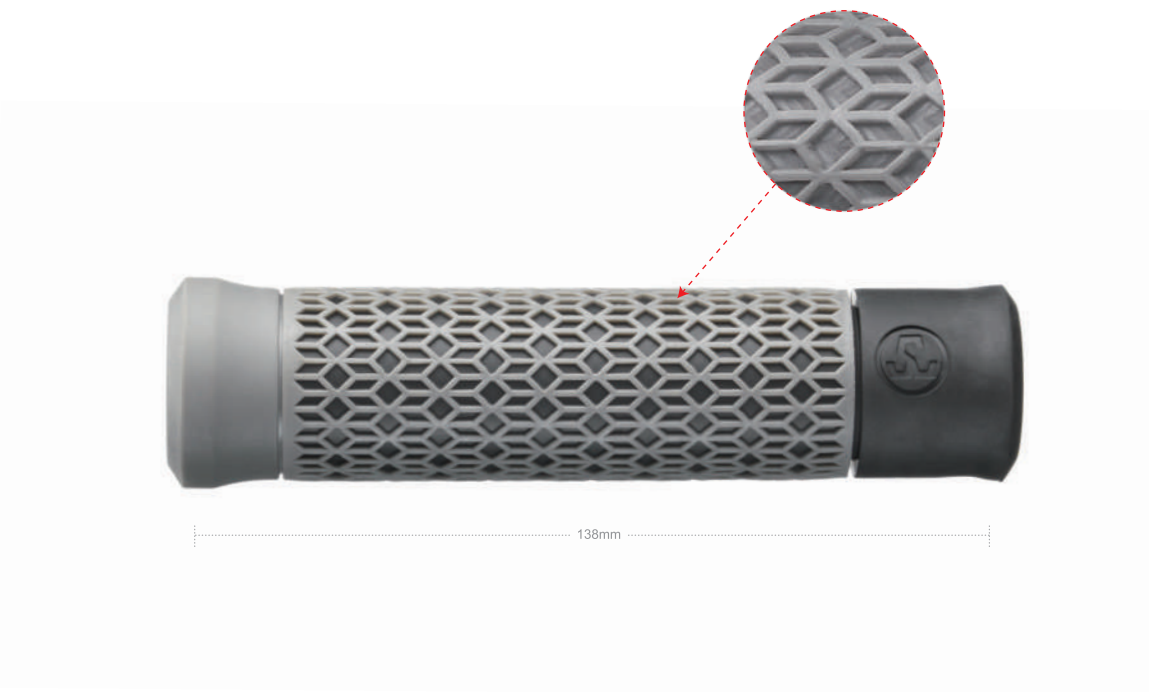

SW-GC-159B Patented Bicycle Grip

- Material: TPR
- A clean and modern look.
- Length: 138mm
- Design for ø22.2mm handlebar
- Duotone colour design

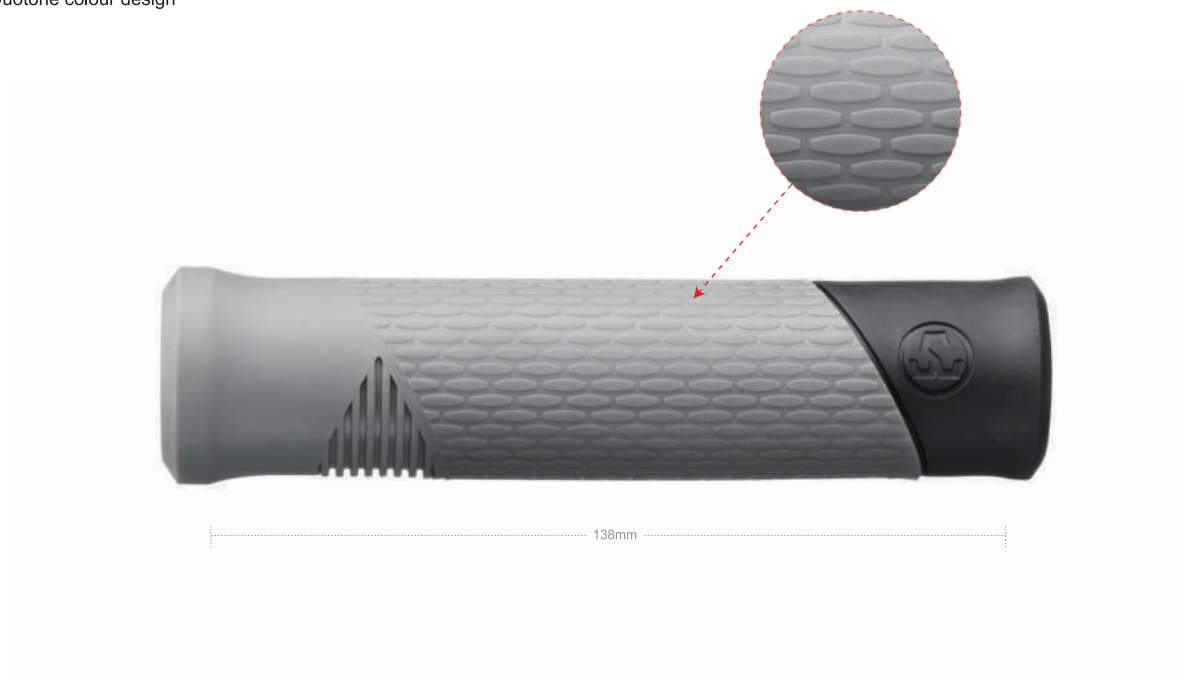

SW-GC-177A/C Bicycle Grip

SW-GC-177A

- Material: Silicone / Rubber
- Length: 132mm
- Design for ø22.2mm handlebar
- Light Weight
- Various colors are available.

SW-GC-177C

- Material: Silicone / Rubber
- Length: 132mm
- Design for ø22.2mm handlebar
- Light Weight
- Various colors are available.

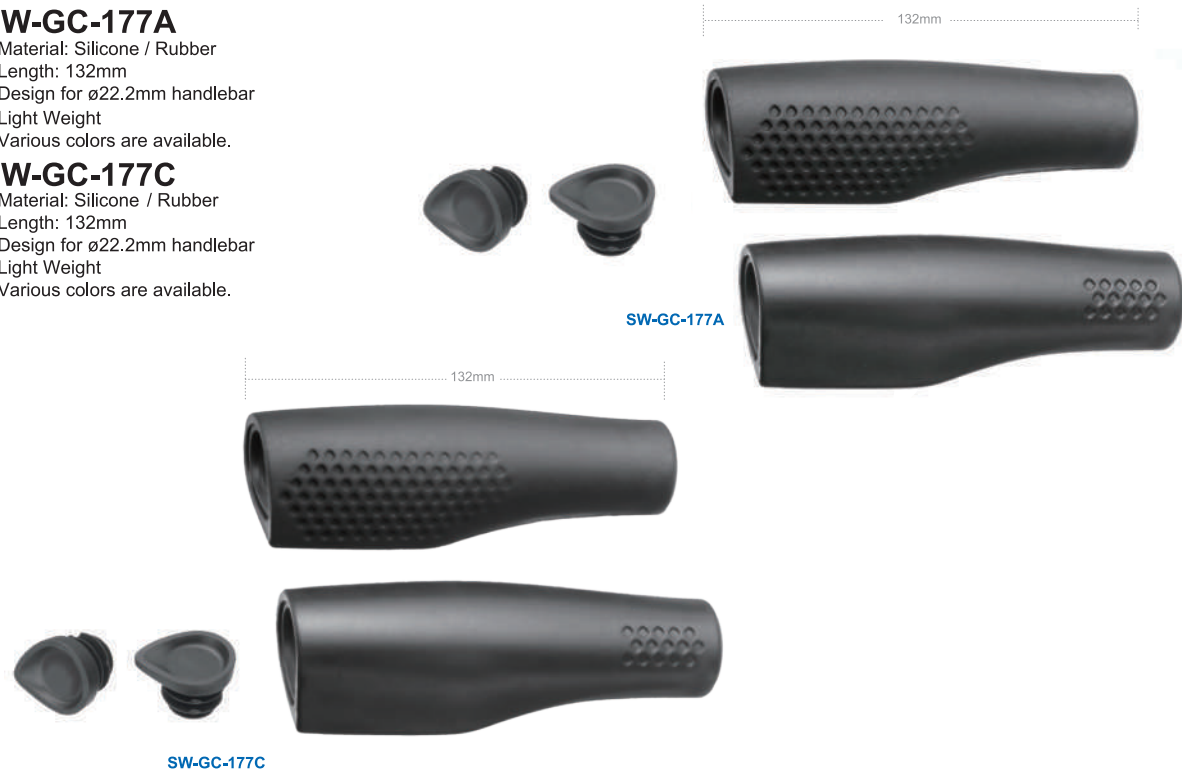

FL-GC-137 Bicycle Grip

- Material: TPR / Aluminum Bar-end
- Length: 135mm
- Design for ø22.2mm handlebar
- Duotone colour design



SW-GC-177B/D Bicycle Grip

SW-GC-177B

- Material: Silicone / Rubber
- Length: 132mm / 100mm
- Design for ø22.2mm handlebar

SW-GC-177D

- Material: Silicone
- Length: 132mm / 100mm
- Design for ø22.2mm handlebar



FL-GC-139 Bicycle Grip

- Material: TPR / PP
- A clean and modern look.
- Length: 138mm
- Design for ø22.2mm handlebar
- Duotone colour design



SW-BM-115 Mirror

- Material: ABS+Coating / PA / Glass
- Fit $\phi 20.5 \sim \phi 22.2$ mm Inner Diameter bar-end.
- Multi-angle adjustable.
- Convex mirror.
- Available in single item (BM-115R / BM-115L).
- Color:

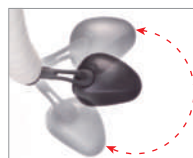
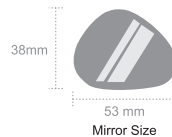

Angle-adjustable

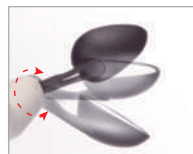

360° Multi-angle Adjustable



Convex Mirror



SW-BM-115A Mirror Patented

- Material: ABS+Coating / PA6 / Glass / Silicone
- Fit $\phi 18 \sim \phi 21$ mm Inner Diameter bar-end.
- Multi-angle adjustable.
- Convex mirror.
- Available in single item (BM-115AR / BM-115AL).
- Color:

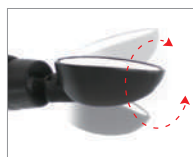
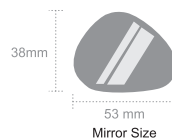

360° Multi-angle Adjustable



Angle-adjustable

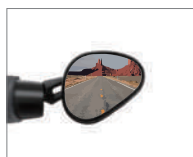

Convex Mirror



SW-BM-111A Mirror Patented

- Material: ABS+Coating / PA / Glass
- Fit $\phi 14.5 \sim \phi 19.5$ mm handlebar-end.
- Multi-angle adjustable.
- Convex mirror.
- Available in single item (BM-111R / BM-111L) or a set.
- Color:

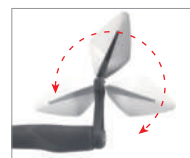
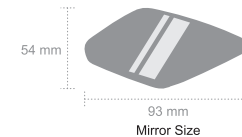

Angle-adjustable



360° Multi-angle Adjustable



Convex Mirror



SW-BM-113A Mirror Patented

- Material: ABS+Coating / PA / Glass
- Fit $\phi 14.5 \sim \phi 19.5$ mm handlebar-end.
- Multi-angle adjustable.
- Convex mirror.
- Available in single item (BM-113R / BM-113L) or a set.
- Color:

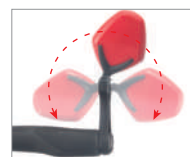
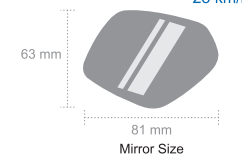

Angle-adjustable



360° Multi-angle Adjustable



Convex Mirror

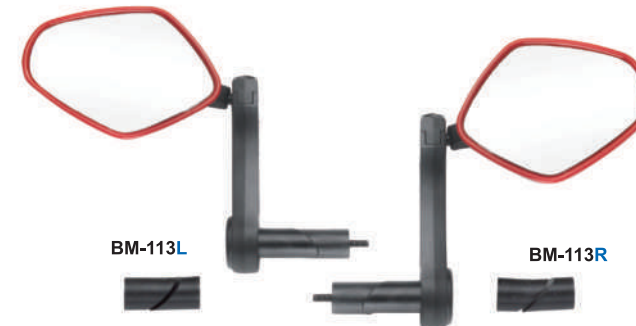

MIRROR

MIRROR

SW-BM-117A Mirror

- Material: PP / PA6 / POM / Glass
- Fit $\varnothing 22.2$ mm handlebar.
- Multi-angle adjustable.
- Convex mirror.
- Available in single item (BM-117AR / BM-117AL) or a set.



Easy Assembly



360° Multi-angle Adjustable



Convex Mirror

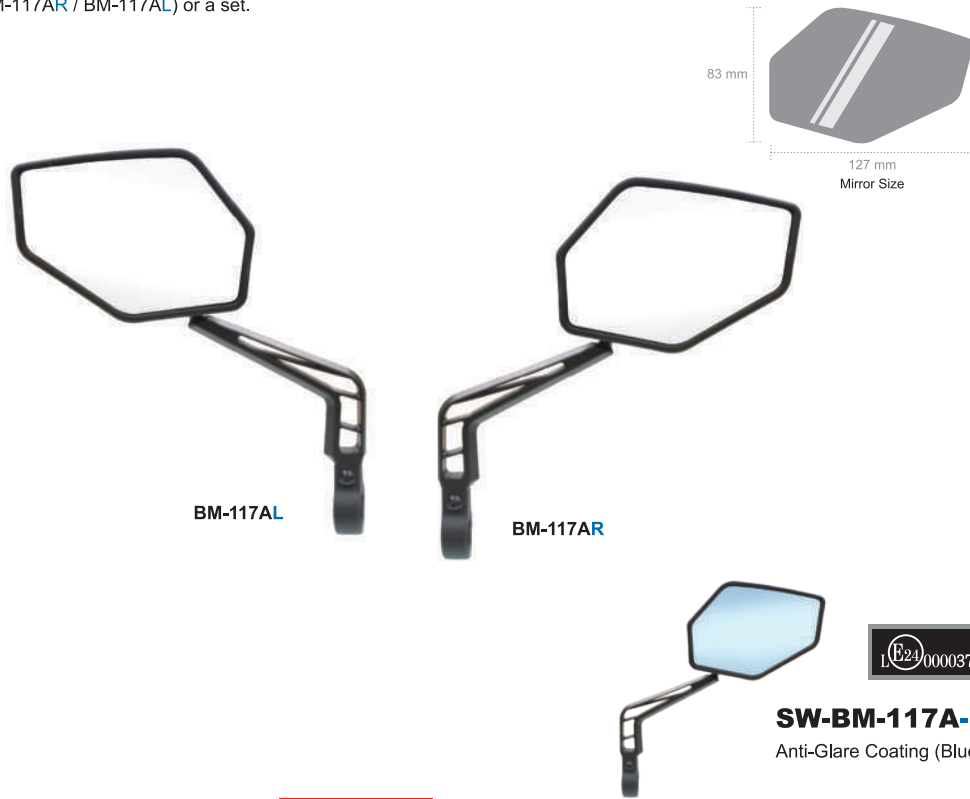

SW-BM-117A-1
Anti-Glare Coating (Blue)

SW-BM-117B Mirror Patented

- Material: PP / PA6 / POM / Glass
- Fit $\varnothing 16.2 \sim \varnothing 20.2$ mm handlebar-end.
- Multi-angle adjustable.
- Convex mirror.
- Available in single item (BM-117BR / BM-117BL) or a set.



360° Bracket Suitable Angle



360° Multi-angle Adjustable



Convex Mirror

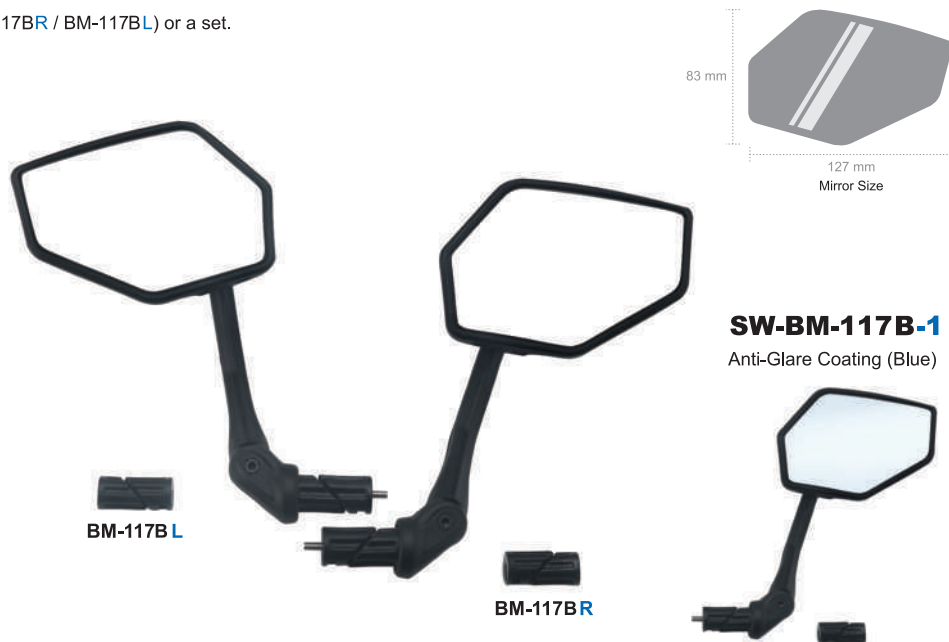

SW-BM-117B-1
Anti-Glare Coating (Blue)

SW-BM-115B Mirror Patented

- Material: PA6 / Glass
- Fit $\varnothing 16 \sim \varnothing 21$ mm Inner Diameter bar-end.
- Multi-angle adjustable.
- Convex mirror.
- Color: ●



Convex Mirror



Reducing aerodynamic drag



Multi-angle Adjustable

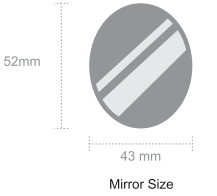

Mirror Size

SW-BM-117 Mirror

- Material: PP / PA6 / POM / Glass
- Fit $\varnothing 14.5 \sim \varnothing 19.5$ mm handlebar-end.
- Multi-angle adjustable.
- Convex mirror.
- Available in single item (BM-117R / BM-117L) or a set.

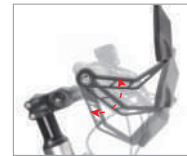

360° Bracket Suitable Angle



Multi-angle Adjustable



Convex Mirror

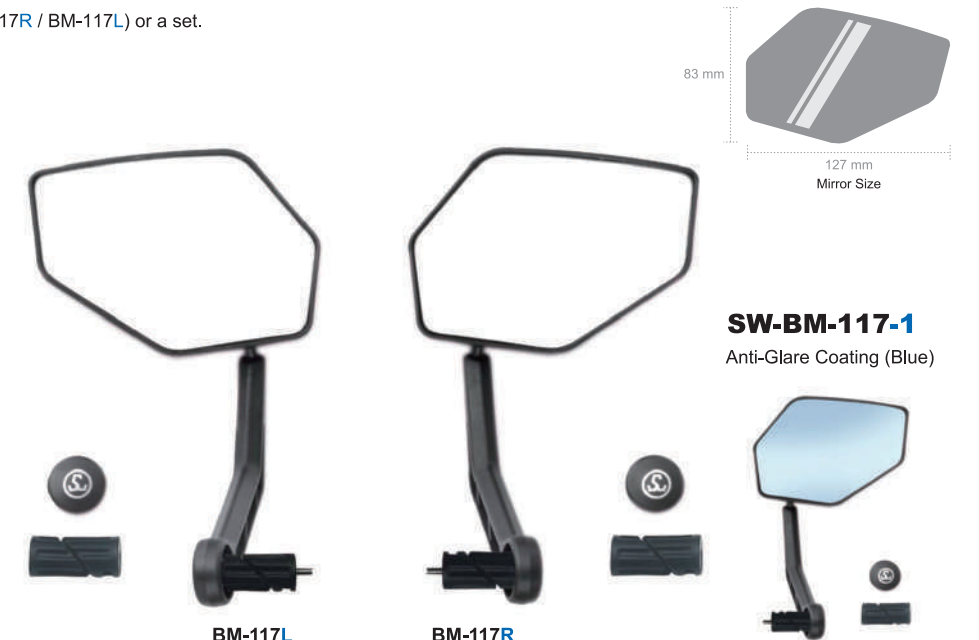

SW-BM-117-1
Anti-Glare Coating (Blue)

MIRROR

MIRROR

SW-BM-117C Mirror

Patented

- Material: PP / PA6 / POM / Glass
- Fit $\varnothing 16.2 \sim \varnothing 20.2$ mm handlebar-end.
- Multi-angle adjustable.
- Convex mirror.
- Available in single item (BM-117CR / BM-117CL) or a set.

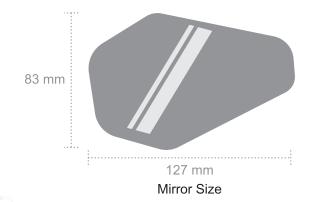

360° Bracket Suitable Angle



360° Multi-angle Adjustable



Convex Mirror

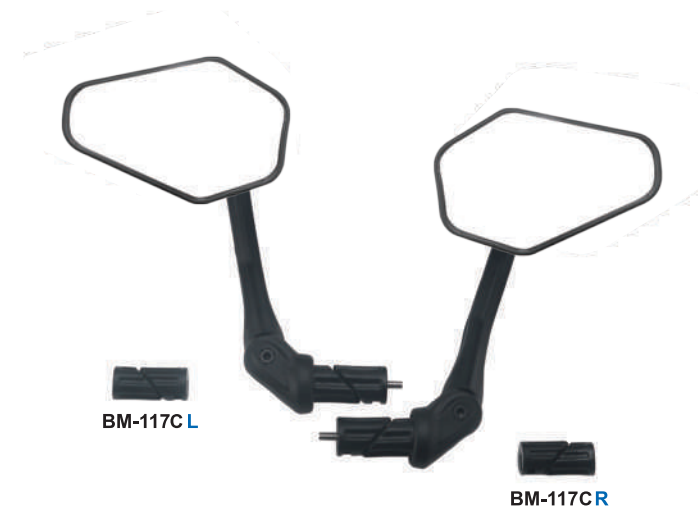

BM-117C L

BM-117C R

SW-RIN-810 Bicycle Ring

- Material : PP / Aluminum
- According by JIS D9451 standard, sound above 75dB.
- Rotatable clapper position.
- Japan-made bell spring.
- Fit ϕ 19~31.8mm handlebar.
- Strike can rotatable in 360°
- Elastic material strip to fit all tubes. (secure the bell in tighten)
- Bell color : Brass (Clear-coated / Silver / ED Black)
- Aluminum (Silver / ED Black)
- Body color : Black / Gray



SW-RIN-900 Bicycle Ring

- Material: PP / Aluminum
- According by JIS D9451 standard, sound above 75dB.
- Fit ϕ 19~22mm handlebar.
- Bell color : Silver / Black.

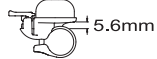

SW-RIN-050 Bicycle Ring

- Material: PP / Aluminum
- According by JIS D9451 standard, sound above 75dB.
- Fit ϕ 19~22mm handlebar.
- Bell color : Silver / Black.



SW-RIN-950 Bicycle Ring

- Material: PP / Aluminum
- According by ISO 7636 standard, sound above 85dB.
- Fit ϕ 19~22mm handlebar.
- Bell color: Silver / Black.

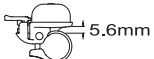

SW-RIN-960 Bicycle Ring

- Material: PP / Aluminum
- According by JIS D9451 standard, sound above 75dB.
- Fit ϕ 19~22mm handlebar.
- Bell color: Silver / Black.

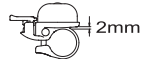

SW-RIN-100 Bicycle Ring

- Material: PP / Aluminum
- According by JIS D9451 standard, sound above 75dB.
- Japan-made bell spring.
- Fit ϕ 19~22mm handlebar.
- Bell color: Silver / Black.



SW-RIN-150 Bicycle Ring

- Material: PP / Aluminum
- According by JIS D9451 standard, sound above 75dB.
- Japan-made bell spring.
- Fit ϕ 19~22mm handlebar.
- Bell color: Silver / Black.



SW-Wind Bell Bicycle Ring

- Material: PP / Brass
- According by JIS D9451 standard, sound above 75dB.
- Japan-made bell spring.
- Fit ϕ 22.2mm handlebar.
- Brass bell finish: Silver / Gold.



SW-RIN-1000 Bicycle Ring

- Material: Brass
- According by JIS D9451 standard, sound above 75dB.
- Rotatable clapper position.
- Japan-made bell spring.
- Fit ϕ 22.2 / 25.4mm handlebar.
- Bell color: Clear-coated Brass / Silver
- Body color: Black / Gray



360° Rotatable Clapper



SW-RIN-650 A/B Bicycle Ring

- Material: PP / Aluminum / Brass
- According by JIS D9451 standard, sound above 75dB.
- Rotatable clapper position.
- Japan-made bell spring.
- Fit ϕ 19~22.2mm / 22.2~25.4mm handlebar.
- Choice of Aluminum & Brass bell.
- Aluminum finish: ED / Anodize (Silver).
- Brass finish: Silver / Gold.



SW-RIN-700 Bicycle Ring

- Material: PP / Aluminum / Brass
- According by JIS D9451 standard, sound above 75dB.
- Japan-made bell spring.
- Fit ϕ 19~22.2mm handlebar.
- Choice of Aluminum & Brass bell.
- Aluminum finish: ED / Anodize (Silver).
- Brass finish: Silver / Gold.



SW-RIN-1200P Bicycle Ring

- Material: Brass / Aluminum
- According by JIS D9451 standard, sound above 75dB.
- Fit \varnothing 22.2mm handlebar.
- The same as RIN-1200 bell cap & strike.
- Strike can rotatable in 360°
- Bell color: Brass (Clear-coating / silver)



SW-RIN-1300P Bicycle Ring

- Material: Brass / Aluminum
- According by JIS D9451 standard, sound above 75dB.
- Fit \varnothing 22.2mm handlebar.
- The same as RIN-1300 bell cap & strike.
- Bell color: Brass (Clear-coating / silver)



SW-Grip Bell Bicycle Ring

- Material: Brass / Aluminum
- According by JIS D9451 standard, sound above 75dB.
- Japan-made bell spring.
- Fit \varnothing 22.2 mm handlebar.
- Bell color: Black (Brass) / Silver & Black (Aluminum).



Rotate to make a sound (*short grip only)



• According by JIS D9111 standard.

SW-RIN-1400P Bicycle Ring

- Material: Brass / Aluminum
- According by JIS D9451 standard, sound above 75dB.
- Rotatable clapper position.
- Japan-made bell spring.
- Fit \varnothing 19~22.2mm handlebar.
- Bell color: Brass (Clear-coated)
Aluminum (Silver / ED Black)



SW-RIN-1100 Bicycle Ring

- Material: Brass
- According by JIS D9451 standard, sound above 75dB.
- Rotatable clapper position.
- Japan-made bell spring.
- Adjustable clamp strap to fit \varnothing 22.2 ~ 31.8mm handlebar.
- Bell color: Clear-coated E
- Body color: Black / Gray.



360° Rotatable Clapper



SW-RIN-1200 Bicycle Ring

- Material: Brass / Aluminum
- According by JIS D9451 standard, sound above 75dB.
- Rotatable clapper position.
- Japan-made bell spring.
- Fit \varnothing 22.2 / 25.4mm handlebar.
- Bell color: Brass (Clear-coated / Silver)
Aluminum (Glossy / ED Black)

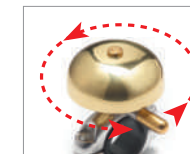

360° Rotatable Clapper



SW-RIN-1400P1 Bicycle Ring

- Material: Brass / Aluminum
- According by JIS D9451 standard, sound above 75dB.
- Rotatable clapper position.
- Japan-made bell spring.
- Fit \varnothing 22.2mm handlebar.
- Bell color: Brass (Clear-coated)
Aluminum (Silver / ED Black)



SW-RIN-1300 Bicycle Ring

- Material: Brass / Aluminum
- According by JIS D9451 standard, sound above 75dB.
- Rotatable clapper position.
- Japan-made bell spring.
- Fit \varnothing 22.2 / 25.4mm handlebar.
- Bell color: Clear-coated (Brass) / Silver (Aluminum).



Lever Design



SW-BC-179 Quick-release Child Seat

- Material: (Seat) PP / TPR (Clamp frame) Steel
- Safety features ensure child passenger's safety.
- Easy installation.
- Best comfort and appearance.
- Color choice: Black / Red / Blue / Gray.
- Max load: 22 kg.



Adjustable Foot-rest



Safety Lock



Holder for Frame (HDA)
ø28~32mm

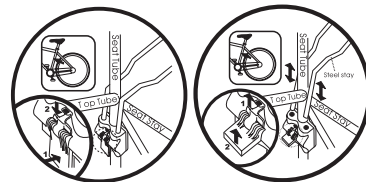

After connecting the steel stay and bracket, the red button must be pushed down. Ensure the bracket is locked correctly and check that the safety device is pushed down.

SW-BC-157 Quick-release Child Seat

- Material: (Seat) PP (Clamp frame) Steel
- Safety features ensure child passenger's safety.
- Easy installation.
- Best comfort and appearance.
- Color choice: Black / Red / Blue / Gray.
- Max load: 22 kg.



Adjustable Foot-rest



Holder for Frame (HDA)
ø28~32mm



3-position Backrest



Backrest Adjust System

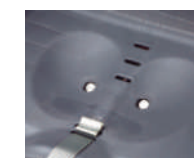

Ergonomic Seat Design



Foldable

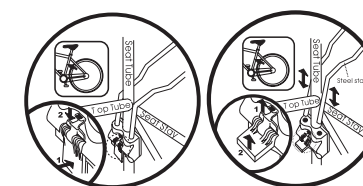

After connecting the steel stay and bracket, the red button must be pushed down. Ensure the bracket is locked correctly and check that the safety device is pushed down.

SW-BC-195 Child Seat (Excluded Bicycle Rack)

- Material: PP / EVA
- Safety features ensure child passenger's safety.
- Easy installation with simple fitting system to the carrier.
- Spoke protection, preventing feet from touching spokes.
- Best comfort and appearance.
- Max load: 15 kg.

BABY BREEZER



Ventilation Design



Adjustable Strap



Comfortable Cushion

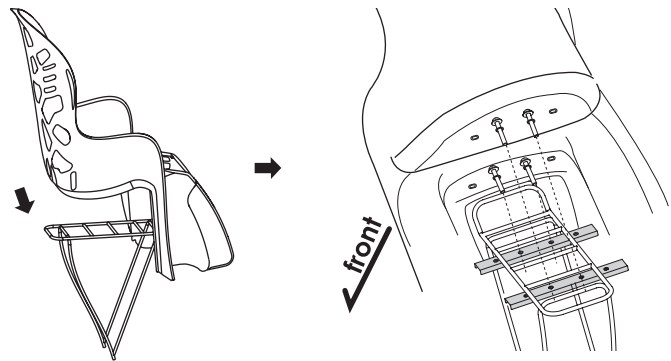
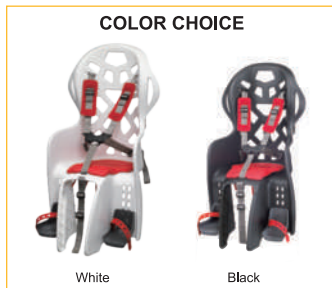

CHILD SEAT

SW-BC-193 Child Seat with Easy-lock Frame

- Material: (Seat) PP / TPR (Clamp frame) Nylon
- Safety features ensure child passenger's safety.
- Reliable Alloy holder installation with easy-release child-seat holding frame.
- Suitable for 2 years above or 9 kgs to max. 22 kgs child.
- Best comfort and elegant appearance.
- D 540 x W 440 x H 725 / Weight: 5 kg.
- Max load: 22kg.



Install on Seat-tube



Tool-free Release



Shoulder & Arm Protect

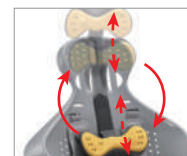

Adjustable Headrest



Easy Adjusting Knob



Comfortable Cushion



Ventilation Design

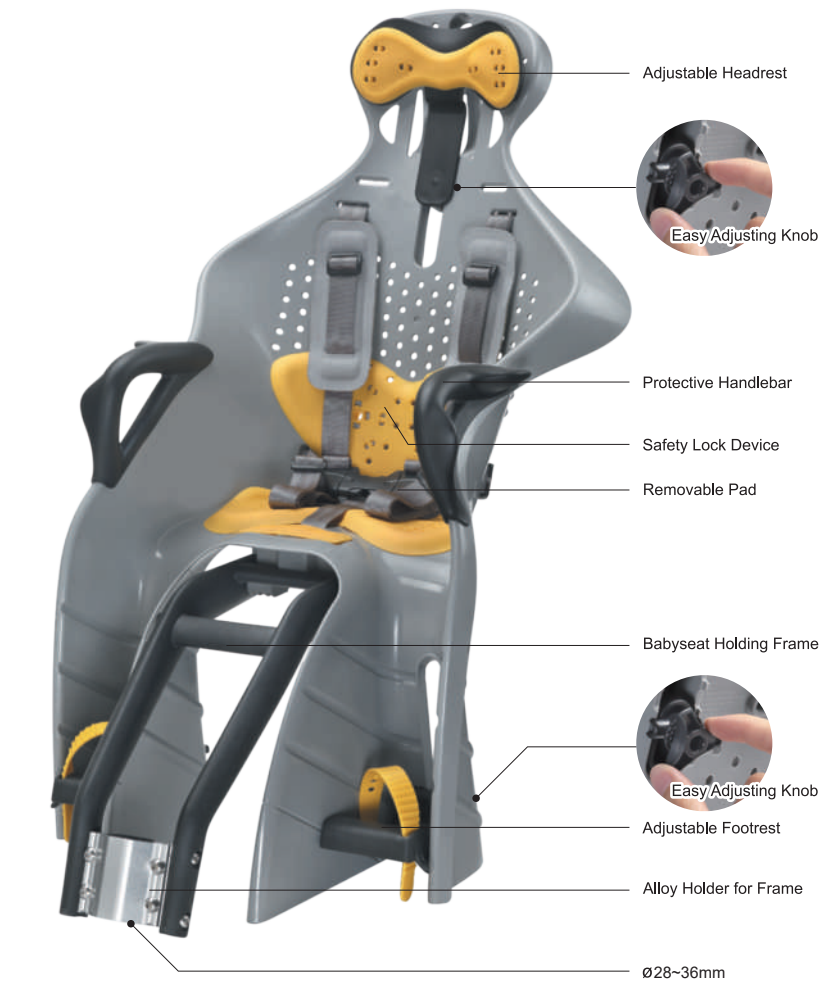

2-steps Safety Lock



Removable Pad



Easy-adjusting Strap



Adjusting Footrest

CHILD SEAT



SW-BC-133 Child Seat

- Material: PP
- Designed and manufactured according to strict safety regulations.
- Safety features ensure child passenger's safety.
- Easy installation.
- Best comfort and appearance.
- Color choice: Black / Red / Blue / Gray.
- Max load: 22 kg.



Standard Steel Stay Fitting

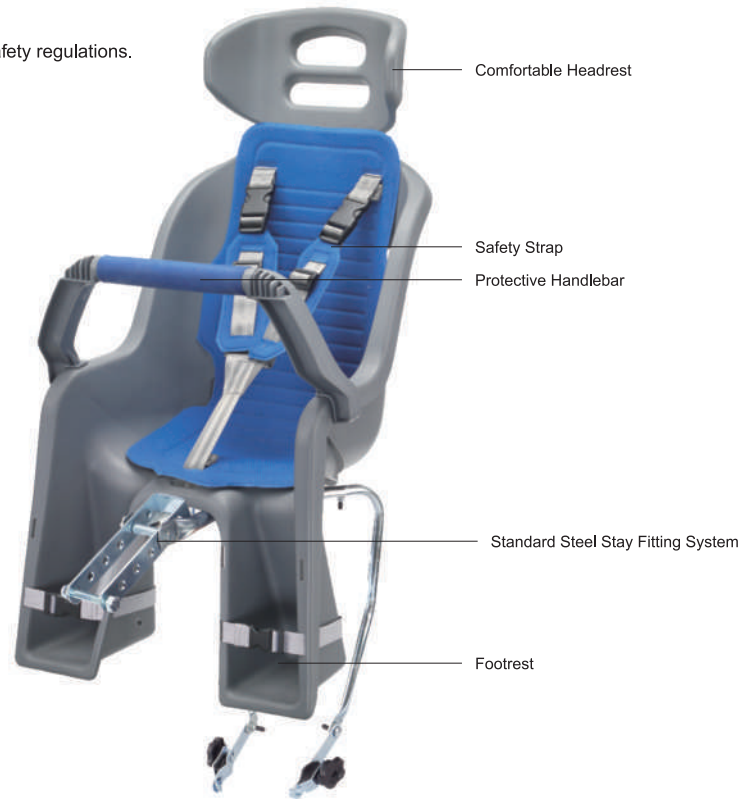

SW-BC-137 Quick-release Child Seat

- Material: (Seat) PP (Clamp frame) Steel
- Designed and manufactured according to strict safety regulations.
- Safety features ensure child passenger's safety.
- Easy installation.
- Best comfort and appearance.
- Color choice: Black / Red / Blue / Gray.



Quick-release Mounting System (HDB) Ø28-32mm

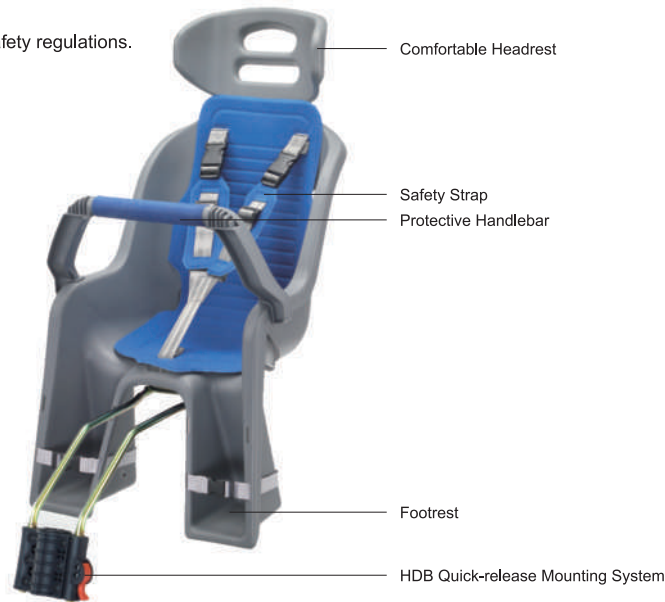

SW-BC-C01A Carrier-fix Child Seat (With Headrest)

- Material: PP / TPR
- Head-rest design avoids child head from swaying while falling asleep.
- Spacious seat and foot-rest space.
- Cushion design provides best comfort.
- Storage guard design may be used as a luggage.
- Suitable for 2 years above or 9 kg to max. 22 kg child.
- Fits 24" ~ 28" bikes.
- Carrier installation.
- *Suggested to install only on ISO approved carriers.
- *Carrier width must be wider than 150 mm.
- *D 700 x W 465 x H 710mm. / Weight: 4 kg.
- *Max. Height: 825 mm . (with head-rest and foot-rest extended.)
- *Exclusive distribution: Japan by BRIDGESTONE.



Adjustable Head-rest



Adjustable Foot-rest



Comfortable Cushion



Storage-guard Design

COLOR CHOICE



SW-BC-C01B Carrier-fix Child Seat (Without Headrest)

- Material: PP / TPR
- D 560 x W 465 x H 535 mm. / Weight: 2.9 kg.
- *Max. Height: 575 mm . (with foot-rest extended.)
- *Exclusive distribution: Japan by BRIDGESTONE.

COLOR CHOICE



HOLDING FRAME SELECTION**SW-RM-111**

- Material: Aluminum / PA6 / GF.
- Fits 26"~28" bike frames.
- Compatible with SW-BC-193 child seat.
- L 500 x W 135 x H 242 mm.

**SW-RM-111A**

- Material: Aluminum / PA6 / GF.
- Fits 26"~28" bike frames.
- Compatible with SW-BC-137 / SW-BC-157 / SW-BC-179 child seat.
- L 500 x W 170 x H 261 mm.



SW-225 Training Wheel

- Material: Steel Stay / Rubber Tire
- Fit 12" ~ 20" bikes.



SW-225F
with Plastic Rim



SW-225G
with Steel Rim

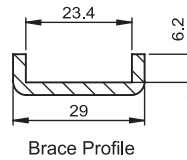

Brace Profile

SW-229 Training Wheel

- Material: Steel Stay / Rubber Tire
- Fit 16"~20" bikes.



SW-229F
with Plastic Rim



SW-229G
with Steel Rim

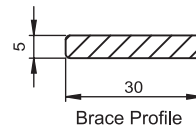

Brace Profile

SW-238 Training Wheel

- Material: Steel Stay / Rubber Tire
- Fit 20" bikes.



SW-238F
with Plastic Rim



SW-238G
with Steel Rim

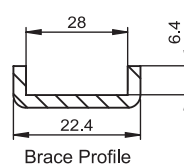

Brace Profile

SW-222 Training Wheel

- Material: Steel Stay / Rubber Tire
- Fit 12"~ 20" / 16"~20" bikes.
- Standard steel stay thickness: 2.8mm.
- TÜV approved steel stay thickness: 3.5mm.
(SW-222FISO / SW222GISO)



SW-222F
with Plastic Rim



SW-222G
with Steel Rim

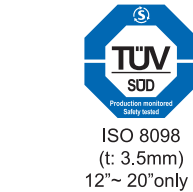

ISO 8098
(t: 3.5mm)
12"~ 20"only

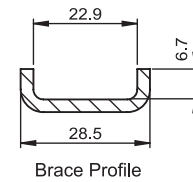

Brace Profile

SW-223 Training Wheel

- Material: Steel Stay / Rubber Tire
- Fit 12"~16" / 12"~20" bikes.



SW-223F
with Plastic Rim



SW-223G
with Steel Rim

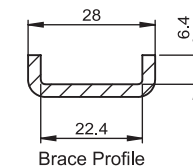

Brace Profile

SW-224 Training Wheel

- Material: Steel Stay / Rubber Tire
- Fit 12"~20" BMX / 12"~16" MTB.
- Standard steel stay thickness: 2.8mm.
- TÜV approved steel stay thickness: 3.5mm.
(SW-224FISO / SW224GISO)



SW-224F
with Plastic Rim



SW-224G
with Steel Rim





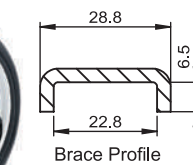





ISO 8098
(t: 3.5mm)
12"~20" only





Brace Profile

Brackets of Training Wheel

FIT MODEL: SW-222, 223, 228, 230, 231 & 233.

 <p>J1 For attaching on the flange nut of rear hub axle.</p>	 <p>J2 Standard bracket.</p>	 <p>J3 (Standard) For attaching on the thicker hexagonal nut of rear hub axle.</p>
 <p>JS For attaching on the thinner hexagonal nut of rear hub axle.</p>		
 <p>N1 Short cross bracket fixed on the chain stay, for MTB with coaster brake.</p>	 <p>N2 Longer cross bracket fixed on the chain stay, for MTB with hand brake.</p>	 <p>N3 Cross bracket fixed on the chain stay, for MTB bike.</p>
 <p>J5R / J5L For attaching on the dropout of MTB bike. For right & left two sides.</p>		 <p>L For outside attaching on the convex "C" shape stay.</p>

FIT MODEL: SW-303

 <p>A Standard bracket.</p>	 <p>A2 For easy pushing upwards and no conflict with the seat stay.</p>	 <p>D Attaching on the dropout of MTB bike.</p>
---	---	--

WHEEL SIZE & SCREW CAP

				
D 126mm	E 126mm	F 131mm	F3 131mm	G 131mm



Screw Cap

FIT MODEL: SW-A011

 <p>A011 Bracket fixed on the chain stay 19mm.</p>	 <p>A011-1 Bracket fixed on the chain stay 26mm.</p>
 <p>A011L Bracket fixed on the chain stay 20mm.</p>	

SW-303D(E) Training Wheel

- Material: Steel Stay / Plastic Rim / PVC Tire
- Fit 12" / 14" / 16" / 18" / 20" bikes.



SW-303D



SW-303E



SW-303D
with Decorative Rim

SW-303E
with Regular Rim

Brace Profile

SW-323D(E) Training Wheel

- Material: Steel Stay / Plastic Rim / PVC Tire
- Fit 12"~14" / 14"~16" / 16"~18" / 18"~20" bikes.



SW-323D



SW-323E



SW-323D
with Decorative Rim

SW-323E
with Regular Rim

Brace Profile

SW-A011 Training Wheel

- Material: Steel Stay / Rubber Tire
- Fit 12"~20" BMX / 12"~16" MTB.
- Standard steel stay thickness: 2.8mm.
- TÜV approved steel stay thickness: 3.5mm.
(SW-A011FISO / SWA011GISO)

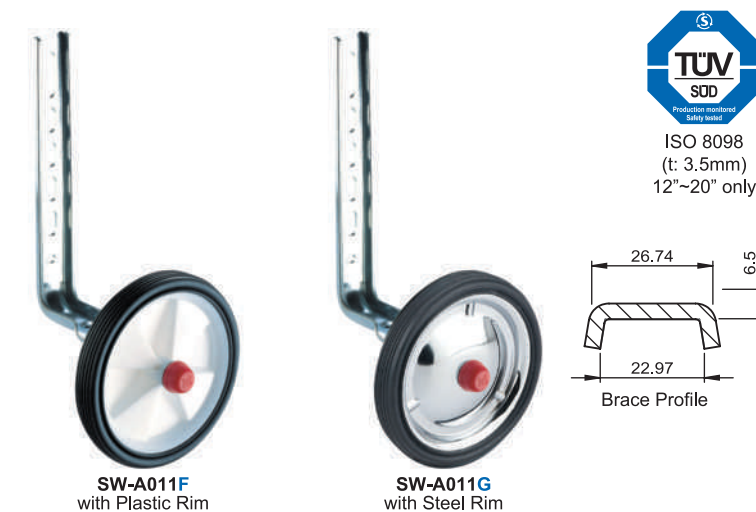

SW-A011F
with Plastic Rim

SW-A011G
with Steel Rim



ISO 8098
(t: 3.5mm)
12"~20" only

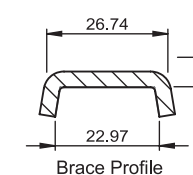

Brace Profile

SW-414 Cable Guide Flange

• Material: PA6



SW-414A
Clip guide for 2-way cable
Fit $\phi 5\text{mm}$ cable.



SW-414B
Clip guide for 1-way cable
Fit $\phi 5\text{mm}$ cable.



SW-414C
Clip guide for 2-way cable
with security cap
Fit $\phi 5\text{mm}$ cable.



SW-414D
Clip guide for 1-way cable
with security cap
Fit $\phi 5\text{mm}$ cable.



SW-414E
1 or 2-way cable joint
Fit $\phi 5\text{mm}$ cable.



SW-414F
Clip guide for 2-way cable
with security cap
Fit $\phi 5\text{mm}$ cable.



SW-414F1-1
Clip guide for 2-way cable
with single rib
Fit $\phi 4 / \phi 5\text{mm}$ cable.



SW-414F2
Clip guide for 2-way cable
with double rib
Fit $\phi 4\text{mm}$ cable.



SW-414G
Clip guide for 1-way cable
with security cap
Fit $\phi 5\text{mm}$ cable.



SW-414I
Clip guide for 2-way cable
Fit $\phi 5\text{mm}$ cable.



SW-414H
Seattube clamp with
cable-guard

SW-415 On-frame Cable Guide



SW-415
• Material: TPR
• Fit $\phi 4.3\text{mm}$ cable.
• Frame tube: t 2mm

SW-415A On-frame Cover



SW-415A
• Material: TPR
• Frame tube: t 2mm

SW-416 On-frame Cable Guide



SW-416
• Material: TPR
• Fit $\phi 4.3 / \phi 6\text{mm}$ cable.
• Frame tube: t 2.9mm

SW-417 On-frame Cable Guide



SW-417
• Material: TPR + PP
• Fit $\phi 4.3\text{mm}$ cable.
• Frame tube: t 2mm

SW-412(A/B) Handlebar Price / Information card Holder

• Material: PP
• Fix on handlebar to hold price card.



SW-412



SW-412A(B)



SW-412
Regular Price-card Holder
(fit $\phi 7/8"$ handlebar)



SW-412A
Wider Price-card Holder
(fit $\phi 7/8"$ handlebar)

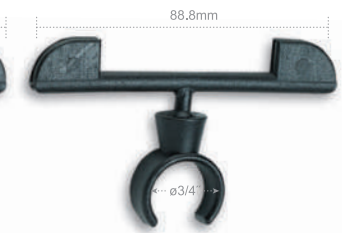

SW-412B
Wider Price-card Holder
(fit $\phi 3/4"$ handlebar)

HUB CAP Hub & Seat Clamp Cap

• Material: PP



HUB CAP E
• Fit $3/8"$ hub nuts.
• Size: 15mm.



HUB CAP F
• Fit $5/16"$ hub nuts.
• Size: 14mm.



SEAT CLAMP CAP G
• Fit M8 nuts.
• Size: 13mm.

SW-RH1 Reflector Connector

- Vertical angle adjustable.
- Fit all Sunny Wheel reflector brackets on fork & seat stay bridge.



Fit reflector with screw or nut fixing.



Fit Cateye / Sate-lite reflector with slide-in fixing.



SW-RH3 Reflector Connector

- Vertical angle adjustable.
- Fit all Sunny Wheel reflector brackets on handlebar.



Fit reflector with screw or nut fixing.



Fit Cateye / Sate-lite reflector with slide-in fixing.



SW-608C

Wall-mount Bicycle Hanger

- Material: Steel / TPR
- 608C: for MTB / Tire width within 2.5".



SW-608C



SW-608C

SW-608D

Wall-mount Bicycle Hanger

- Material: Steel / TPR
- 608D: for Roadbike / Tire width within 35C.



SW-608D



SW-608D

SW-608F

Wall-mount Bicycle Hanger

- Material: Steel / TPR
- 608F: for E-BIKE / Tire width within 3".



SW-608F

REFLECTOR HOLDER

- Material: PA66 + 33%GF
- Angle adjustable.



SW-508 Series

REFLECTOR POST CLAMPS



SW-508A

FIT TO VARIES SIZES OF SEAT STAY TUBES

- 15mm screw to fit ϕ 14.2-15mm tube
- 18mm screw to fit ϕ 15-15.6mm tube
- 20mm screw to fit ϕ 15.8-16.2mm tube



SW-508B

FIT TO VARIES SIZES OF SEAT STAY TUBES

- 15mm screw to fit ϕ 18-19.4mm tube
- 18mm screw to fit ϕ 19.2-20mm tube
- 20mm screw to fit ϕ 19.8-20.4mm tube



SW-508C

FIT TO VARIES SIZES OF SEAT POST & HEAD TUBES

- 15mm screw to fit ϕ 20.4-22.6mm tube
- 18mm screw to fit ϕ 22.6-23.2mm tube
- 20mm screw to fit ϕ 23.2-23.8mm tube



SW-508D

FIT TO VARIES SIZES OF SEAT POST & HEAD TUBES

- 15mm screw to fit ϕ 25.2-26.4mm tube
- 18mm screw to fit ϕ 26.4-27mm tube
- 20mm screw to fit ϕ 27-27.6mm tube



SW-508E

FIT TO VARIES SIZES OF SEAT POST & HEAD TUBES

- 15mm screw to fit ϕ 27.2-28.6mm tube
- 18mm screw to fit ϕ 28.4-29.2mm tube
- 20mm screw to fit ϕ 29-30mm tube



SW-508F

FIT TO VARIES SIZES OF SEAT POST & HEAD TUBES

- 15mm screw to fit ϕ 30.2-31.6mm tube
- 18mm screw to fit ϕ 31.4-32.2mm tube
- 20mm screw to fit ϕ 32-33mm tube



SW-508G

FIT TO VARIES SIZES OF SEAT POST & HEAD TUBES

- 15mm screw to fit ϕ 20.4-21.4mm tube
- 18mm screw to fit ϕ 21.2-21.8mm tube
- 20mm screw to fit ϕ 21.8-22.6mm tube



SW-508H

FIT TO VARIES SIZES OF SEAT POST & HEAD TUBES

- 15mm screw to fit ϕ 24.0-25.2mm tube
- 18mm screw to fit ϕ 25.2-25.8mm tube
- 20mm screw to fit ϕ 25.8-26.6mm tube

SW-PT01 Front-wheel Alignment Gear

- Material: PA6 / POM / PP / ED Steel
- Fit $\varnothing 28.6\sim 32\text{mm}$ downtube to align front wheel straight.

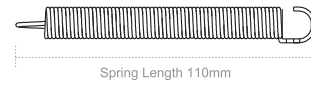

SW-PT01-62 Front-wheel Alignment Gear

- Material: PA6 / POM / PP / ED Steel
- Adjustable strap to fit $\varnothing 38\sim 62\text{mm}$ downtube to align front wheel straight.



SW-PT02 Front-wheel Alignment Gear

- Material: PP / SUS304
- Fit on built-in bracket of downtube to align front wheel straight.

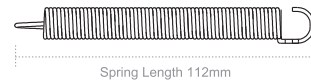

SW-AQ-111 Chain Jam Protector

- Material: Nylon
- Keeps the chain on the chain rings and prevents chain jam in case of an over-shift.
- For seat-tube $\varnothing 28.6 / \varnothing 31.8 / \varnothing 34.9\text{mm}$.



Prevents Chain Jam



AQ-111A1
 $\varnothing 28.6\text{mm}$

AQ-111B1
 $\varnothing 31.8\text{mm}$

AQ-111C1
 $\varnothing 34.9\text{mm}$

SW-BN Valve Caps

Material: Brass



SW-BNA
Tube valve EV to AV



SW-BNB
Tube valve FV to EV



SW-BNC
Tube valve AV to hand-pump EV



SW-BND
Tube valve FV to AV



SW-BNE
Tube valve AV to EV



SW-BNF
Tube valve AV to EV



SW-BNI
Tube valve EV 90° elbow

SW-AC-513 Can Holder

- Material: PP
- Fit $\phi 19\sim\phi 22.2$ mm handlebar



Fit Most Regular Cans

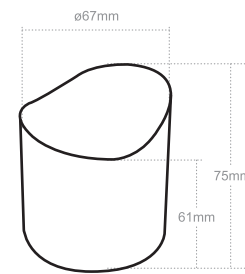

SW-AC-511A Aluminum Cup Holder

- Material: Aluminum
- Customizable colors.
- Fit $\phi 22.2\sim\phi 35$ mm handlebar
- L 130 x H 40 mm / Weight: 80g.



Fit Most Regular Cups

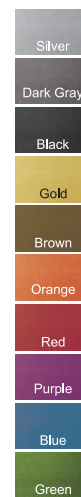
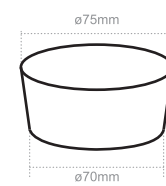

SW-PT03 Front-wheel Alignment Gear

- Material: PP / SUS304
- Fit on built-in bracket of downtube to align front wheel straight.



SW-PT03-B Front-wheel Alignment Gear

- Material: PP / SUS304
- Fit on built-in bracket of downtube to align front wheel straight.

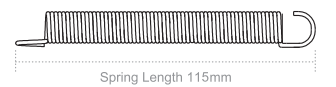

SW-PT05 Front-wheel Alignment Gear

- Material: PA6 / POM / PP / ED Steel
- Adjustable strap to fit $\phi 38\sim\phi 62$ mm downtube to align front wheel straight.
- Exclusively designed for front-suspension bikes.



SB1 Connector
Fit $\phi 18.5\sim\phi 25.4$ mm
Inner Head-tube.

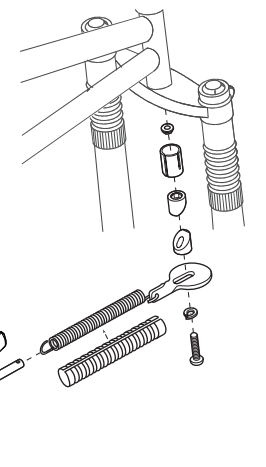
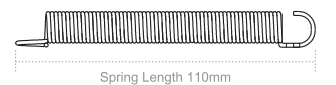

SW-BH-115 Bottle Cage Patented

- Material: PA6
- Fit ϕ 74~76mm bottle.
- For Right-handed & Left-handed.



Flexibility in Use



Water Bottle



Customized Logo Available



Customized Shape Available



SW-BH-113L Bottle Cage Patented

- Material: PC / ABS / Aluminum
- Fit ϕ 72~ ϕ 80mm PET bottle
- For ϕ 72.5 ~ ϕ 81mm Stainless Water Bottle (27oz Classic and insulated bottle)



Adjustable length and width



Length Adjustable



Stainless Water Bottle (27oz)



SW-MH-111 Phone Holder Patented

- Material: TPE / PA6
- Fit length 145~190mm smart phone.
- For ϕ 22.2~ ϕ 31.8 handlebar.
- Easy assembly tool free.



Fit various size



Straight or horizontal



High stability

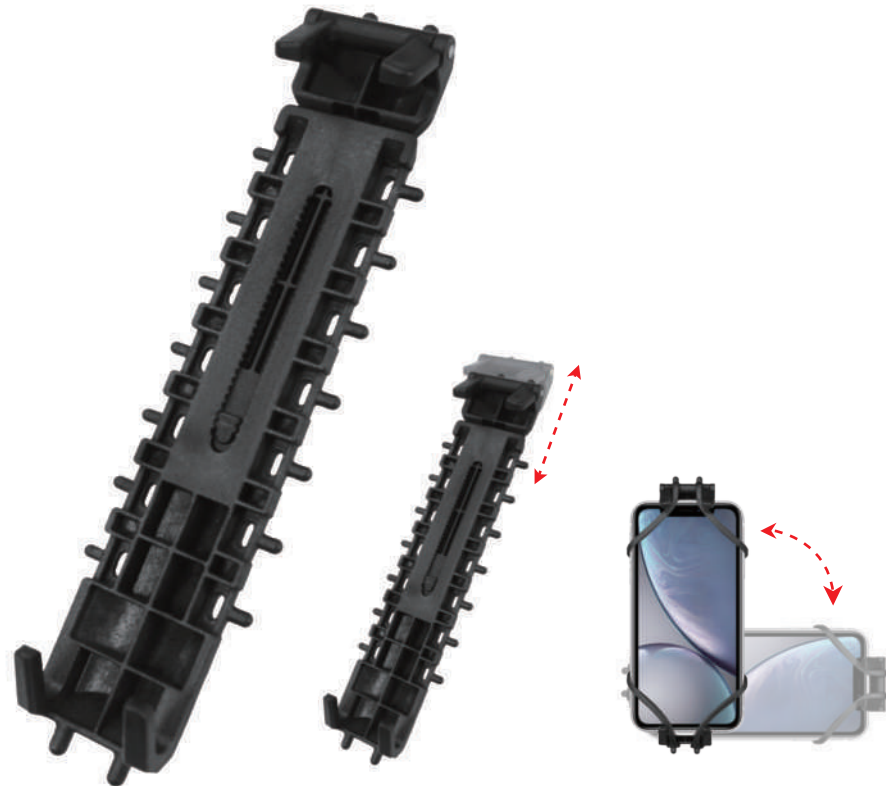

SW-BH-113 Bottle Cage Patented

- Material: PC / ABS / Aluminum
- Fit ϕ 72~ ϕ 80mm PET bottle
- For ϕ 72.5 ~ ϕ 81mm Stainless Water Bottle (18oz Classic and insulated bottle)



Length Adjustable



PET Water Bottle



Stainless Water Bottle (18oz)



SW-KS-111 Portable Bicycle Side Stand **Patented**

- Bicycle wheel size only for 26"~29" include (700C)
- Length adjustable
- Soft edge design preventing scratch on the chainstay
- L 240 x W40 x H25mm / Weight: 128.5g



